





INSTRUCTION MANUAL

HANDHELD THERMOMETER HD-1400 Series

2nd edition Feb., 2012

ANRITSU METER CO., LTD.

2-4-5 Shimomeguro, Meguro-ku,
Tokyo 153-0064, Japan
TEL +81-3-3491-9181
FAX +81-3-3493-6729



TO ENSURE SAFE AND RELIABLE OPERATION

Please observe the following matters to ensure safe and reliable operation of products.

Caution

- This product should not be used for any purpose except temperature measurement.
- Stop using as soon as any problems are discovered.
- Do not take the unit apart or remodeling.
- Use the specified battery cells.
 - ※This product is not rechargeable model.
- Under Electromagnetic environment, Instrument may measure unstably.

Concerning the battery cells

Please observe the following matters to guard the battery leakage, exothermic reaction and ignition.

Warning

- Do not throw away the battery cells in the fire, and avoid short between electrodes.
- Do not charge or heat.
- Use the specified battery cells.

Caution

- Set the battery cells correctly 「+」 and 「-」 .
- Remove the battery cells when the battery life is finished, or long time no using.
- Do not mix old and new, or variety battery cells.
- The battery life will be affected by the environmental temperature.

Preface

Thank you for purchasing this product from ANRITSU METER CO., LTD.

We prepared this manual so that you can use this product with ease and confidence.

Please read this manual carefully and understand each functions of this product for your safety and correct using.

Caution

- This contents and the specification of this product are subject to change without notice.
- Reproduction in part or whole of any material from this booklet is prohibited by law.
- We surely make this manual, however if there are any error or not clear, please contact the place of purchase or us.
- We are not responsible for the consequences of using this product.

Warranty and After-sales Service

ANRITSU METER CO., LTD. ships products after severe company's inspection. Should you find any failure resulting from poor material and workmanship or accident during transportation, please contact the place of purchase or us.

We recommend that you may use the original packaging for this product when you send it to us for repairing or periodical checkup. If you no longer have the original carton, be sure to use plenty of wrapping to guard against damage during shipping.



e2



CONTENTS

1. General	e4
2. Unpacking	
2.1. Unpacking.....	e4
2.2. Repacking.....	e4
3. Name of Components	
3.1. Name of Components.....	e5
3.2. Display of all segments	e6
4. Preparation for Operation	
4.1. Battery Installation	e7
4.2. How to Use Hand Strap.....	e8
4.3. Sensor Setting.....	e9
4.4. Soft case.....	e9
5. Operation	
5.1. Power ON / OFF.....	e10
5.2. Hold.....	e10
5.3. Automatic Power OFF	e11
6. Default Configuration	e11
7. Indicator of Battery remain	e12
8. Error Messages	
8.1. Indication of Sensor Burnout.....	e13
8.2. Indication of Over range.....	e13
8.3. Indication of Error.....	e14
8.4. Indication of Exhausted Battery.....	e14
9. Maintenance	
9.1. Storage.....	e15
9.2. Case cleaning.....	e15
10. In case of Trouble	e16
11. Specification	e17

1. General

This handheld thermometer allows easy temperature measurement.

These general-purpose thermometers can be used for on-site temperature measurement and various other applications.

A microprocessor is used for constant compensation of zero-point and full scale, thus ensuring extremely stable, high precision measurement.

2. Unpacking

2.1. Unpacking

Open the carton and check that the following are provided. If any of them is missing or out of order, please contact the place of purchase or us.

1. Main unit
2. Soft case
3. AA-size alkaline battery cells
4. Hand Strap
5. Instruction manual
6. Test Report

2.2 Repacking

Use the original carton of the instrument for its transportation by mail or car. If the original case is not available, carefully wrap the instrument in shock-absorbing material (polystyrene foam and the like). Wrapping material should be dry and free of dust generation otherwise the instrument may be damaged.

3. Name of Components

3.1. Name of Components (MODEL: HD-1450)

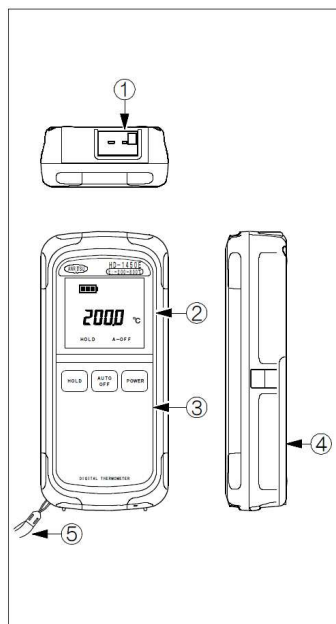

- ① Sensor Input connector
- ② LED Display
- ③ Key switch panel
- ④ Battery housing
- ⑤ Hand strap

3.2. Display of all segments

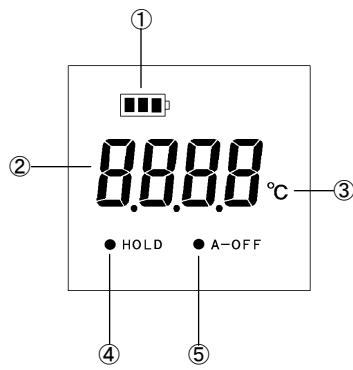

- ① Battery Indicator
- ② Main Display
- ③ °C
- ④ Hold
- ⑤ Auto Power OFF

4. Preparation for Operation

4.1. Battery Installation

Be sure to keep the power OFF during the battery cells change.

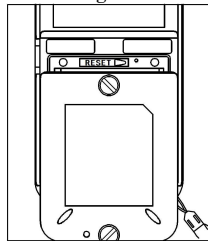

(1) Remove the two screws and detach the battery housing cover.

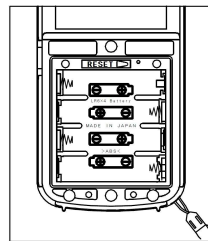

(2) Set battery cells correctly.

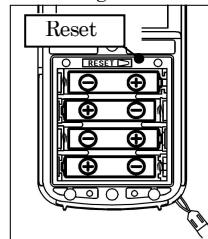

(3) After setting battery cells, press the Reset switch.

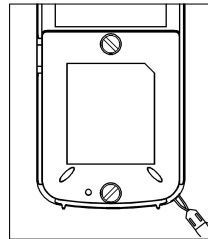

(4) Reattach the battery housing cover, tighten the two screws and press the edges of the battery housing cover firmly.

●The Reset switch is a small push button in the upper section of the battery housing. Use a thin stick to lightly press it. Please do not push with the breakable object.

※To maintain waterproof properties, make sure that the battery housing cover is not partially open when reattaching the battery housing cover.

4.2. How to Use Hand Strap

Hang the hand strap around the hand to prevent in advertent drop of the instrument.

Thread the fine cord end of the hand strap through the strap attachment on the instrument. Pull the hand strap end through the loop.

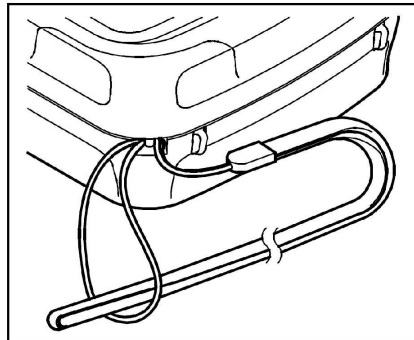

4.3. Sensor Setting

Set the sensor as shown.

The plug is so designed that it will not be set when the polarity is reversed.

Forcible insertion will damage the instrument.

Be sure to check the polarity.

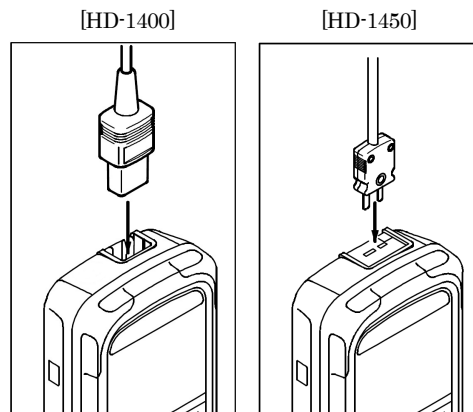

4.4. Soft case

Use the attached soft case for protection instrument against dirt or flaw.

5. Operation

5.1. Power ON/OFF

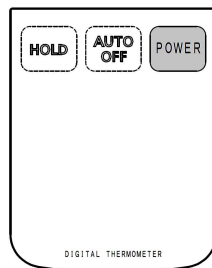

Press the **Power** key to turn power ON and all segments appear on the display for 1 second, and start measurement as be shown below.
Press the key again to turn power OFF.

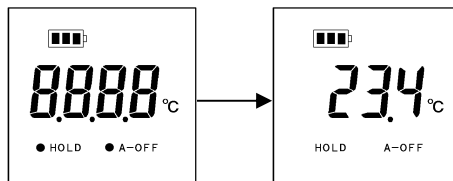

5.2. Hold

Press the **HOLD** key to stop measurement and show the measured Temperature on the display.
Then HOLD appears on the display.
Press the key again to return to the normal mode.

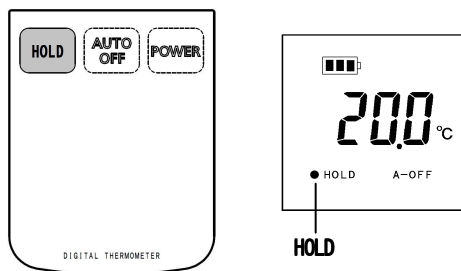

5.3. Automatic Power OFF

Press the **AUTO OFF** key to enter the Automatic Power OFF mode that is provided to automatically turn Power OFF after a certain period times (about 5 minutes) no key operation. Press the key again to return to normal mode.

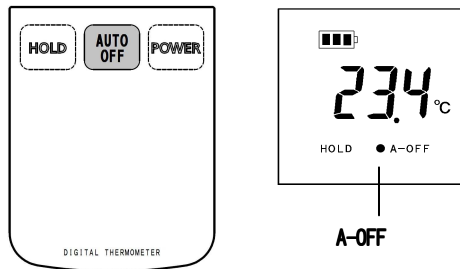

6. Default Configuration

When the instrument turns power OFF, Reset or Battery exchange, some setting will be canceled. Default Configuration is below tables.

Function	
HOLD	Cancel
Auto Power OFF	Default

7. Indicator of Battery remain



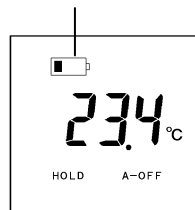

The battery level is indicated in the upper section of the display.

In accordance with operation hours, the indicator lights go out as shown below.

Battery level



This table is tentative value because of the battery remains according to variety battery specification.

Indicator	Battery remain
	Over 60%
	60~10%
	Under 10%
Blink → 	Exhausted Battery

This instrument can work for a while after the Exhausted Battery sign appears. However, Change battery as soon as possible, otherwise satisfactory function will not be available.

8. Error Messages

8.1. Indication of Sensor Burnout

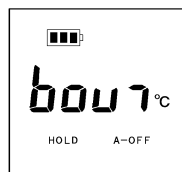

If the sensor burns out or is not coupled, the Burnout display appears shown as left.

Check whether the sensor burns out or does not connect to instrument.

8.2. Indication of Over range

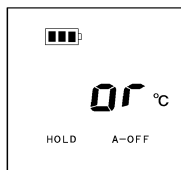

If the temperature exceeds the measurable range during measuring, the Over range display appears shown as left.

- If the sensor is almost cut, the Over range display sometimes appears.

Please check the sensor cut if measuring temperature is in the range.

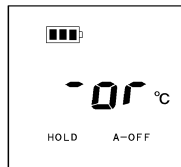

- The over range display does not damage the instrument, however the sensor will be exhausted. Avoid the sensor to the place in measurable temperature.

8.3. Indication of Error

The instrument is broken, please contact the place of purchase or us.

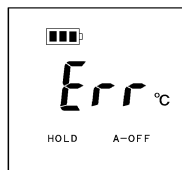

8.4. Indication of Exhausted Battery

When the battery is exhausted, Battery indicator blinks.

Then replace the old battery cells with new ones.

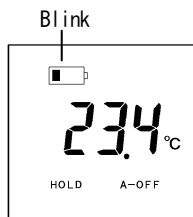

9. Maintenance

9.1. Storage

Avoid places subject to the following when storing the instruments.

- Direct Sunlight
- Strong vibration
- High humidity (85%RH or more)
- Hot atmosphere (50°C or more)
- Dust, corrosive gas, or salt
- Strong electromagnetic field

It is recommended to put the instrument in the original case when storing it for a long time.

9.2. Case cleaning

When the case is dirty, lightly wipe it with a cloth slightly impregnated with water.

Do not use thinner or benzene, otherwise the case or keyboard may discolor or deform.

Water resistance

The HD-14*0 feature basic water resistance (equivalent to the IPX5 standard).

The instrument can be rinsed using a small amount of water. However, take care to keep water from entering the air hole near the battery housing.

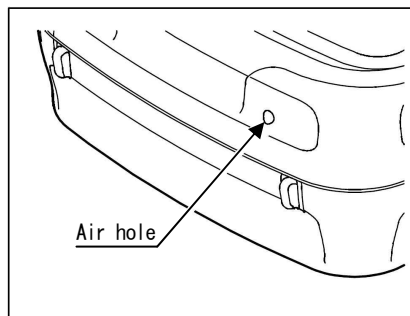

10. In case of Trouble

Issues of instruments operation trouble, please check follows. If your trouble is not solved, please contact the place of purchase or us.

- (1) **Display does not show any segments.**
 - **Push the Reset switch**
 - **Check the pole of battery cells**
 - **Replace the old battery with new ones**

- (2) **Measurement value does not stable.**
 - **If sensor is deformation or broken junction, please contact us for repairing.**
 - **Pull out and put in the plug of the sensor with the instrument again.**
 - **If the sensor does not hold in the correct position, measurement value does not stable.**
 - **If you measure in the environment of strong electromagnetic field (a big motor, etc.), please shield the instruments and the sensor against electrical noise.**

- (3) **Measurement value error is too big (Not acceptable).**
 - **If the thermocouple type of the sensor is not corresponded to the instruments, measurement value is not correct. Please replace the correct sensor.**
 - **If sensor is deformation, please contact us**

- (4) **The key switch is not operated**
 - **When the Burn out display appears, no operation. Please put the sensor in, or check the sensor broken junction.**

11. Specification

Display	7 segments LED
Operation key	Membrane switch
Water-resistant construction	Equivalent to IPX5
Linearizer	Digital (based on JIS C 1602-1995)
Sampling rate	Approximately 300 ms
Signal source resistance	500Ω
Power supply	Battery cells (AA) 4 pieces or AC adaptor
Battery life	Approximately 150 h
Environmental limit	Operation: 0~40°C, 0~80% RH Storage: -20~50°C, 0~85%RH
Dimensions	76(W)×167(H)×36(D)mm
Weight	Approximately 350 g
Accessories	Soft case Hand Strap Instruction manual Test Report Battery cells (AA) 4 pieces

Accuracy

E	Measurement range	1°C	-205~805°C
		0.1°C	-104.9~504.9°C
	Accuracy 1°C resolution	0°C or more	±(0.1% of reading + 1°C)
		Below 0°C	±(0.5% of reading + 1°C)
	Accuracy 0.1°C resolution	0°C or more	±(0.05% of reading + 0.2°C)
		Below 0°C	±0.5°C
K	Measurement range	1°C	-205~1372°C
		0.1°C	-104.9~504.9°C
	Accuracy 1°C resolution	0°C or more	±(0.1% of reading + 1°C)
		Below 0°C	±(0.5% of reading + 1°C)
	Accuracy 0.1°C resolution	0°C or more	±(0.05% of reading + 0.2°C)
		Below 0°C	±0.5°C
Accuracy Cold-junction compensation		0.2°C at 25°C±10°C	
Temperature coefficient		±0.01% of F/S/°C except 25°C±10°C	