

Compact Thermologger
AM-8000 Series
User's Manual

AE-100165
4th edition
January 2013

Anritsu Meter Co.,Ltd.

Safety

To ensure the safe and correct use of this product, as well as maintain accuracy of temperature measurements, the cautions described below should be read thoroughly.

Cautions

- Be sure to use this product only for temperature measurements, and not for any other purpose.
- If any abnormality is detected, immediately stop using the product.
- Do not disassemble or reconstruct this product.
- Do not use power supplies other than commercially available dry batteries and the dedicated mains power supply.

* This product will not recharge rechargeable batteries.

Battery care

To prevent liquid leakage, heat generation, and ignition, always observe the warnings described below.

Warnings

- Do not incinerate, short-circuit, disassemble, or heat any battery.
- Do not attempt to recharge dry batteries.
- Only replace with batteries of the same type.

Cautions

- Observe battery polarity when inserting batteries.
- If a battery is depleted or the equipment is not to be used for a period of time, remove from the equipment.
- Do not use new and old batteries or different types of batteries in combination.
- Battery life varies greatly with the ambient temperature.

Preface

Thank you for purchasing this Anritsu Meter product.

This user's manual is provided to ensure the safe and correct use of Anritsu Meter products, and should be thoroughly read and understood as regards each function of the product before the product is used.

Note:

- The content of this manual and the specifications, appearance, etc. of the product may be changed without prior notice.
- Under copyright law, this manual may not be copied, in whole or part, without the written consent of Anritsu Meter.
- Although the content of this manual is believed to be free of errors, if any omissions in writing or doubts about this manual exist, please contact your distributor or Anritsu Meter.
- Anritsu Meter assumes no responsibility as regards the use of this product, and results thereof.

Guarantee and after-sales service

● Guarantee

Although Anritsu Meter products are subject to strict in-house inspection before they are shipped, if any fault attributable to manufacturing defects or those caused by impact, etc. during transport are discovered, please contact your distributor or Anritsu Meter.

Anritsu Meter products are guaranteed for a period of one year after the date of delivery. Faults occurring within this period for reasons attributable to Anritsu Meter will be repaired free of charge.

Please be aware, however, that faults arising from the following causes will in no case be guaranteed:

- Faults caused by fire, earthquake, and other force majeure
- Faults caused by misuse, improper handling, or disassembly
(Disassembly refers to opening the case or loosening the screws.)
- * Thermocouple sensors from Anritsu Meter are consumables, and are not guaranteed.

● After-sales service

If the Compact Thermologger malfunctions, consult the user's manual to examine the cause of the problem. If the problem cannot be resolved, please contact your distributor or Anritsu Meter.

Repairs during the guarantee period will be accepted based on the content of the warranty card. After the expiration of the guarantee period, repairs will be accepted only when the product functionality can be restored or maintained by repair.

To return Anritsu Meter products for the purpose of repair or calibration, be sure to use the case in which the product was delivered. If the case is not available, wrap the product sufficiently with cushioning material to ensure that the product will not be damaged during transport.

Table of Contents

1. Overview	1
1.1 Product Overview	1
1.2 Features	2
2. Unpacking	3
2.1 Unpacking Your Product	3
2.2 Repacking Your Product	3
3. Preparing for Operation	4
3.1 Part Names	4
3.2 Description of Keys	6
3.3 Power Supply	7
3.3.1 Installing Batteries	7
3.3.2 Using the AC Adapter	7
3.4 Connecting Input Plugs	8
4. Power-on and Initial Screen	9
4.1 Turning the Power On	9
4.2 Description of the Indicated Symbols	10
5. Starting Measurement and Setting Each Item	11
5.1 Types of Measurements	11
5.1.1 Normal Measurement	12
5.1.2 Manual Measurement	14
5.1.3 Real Measurement	15
5.2 Various Settings	16
5.2.1 CHECK (Check Measurement)	17
5.2.2 SET (Various Settings)	18
5.2.2.1 CHANNEL (Channel Setup)	19
5.2.2.2 RESOL (Resolution Setup)	20
5.2.2.3 INT&MNo (Interval and Machine No. Setup)	21
5.2.2.4 CLOCK (Date and Time Setup)	22
5.2.2.5 TIMER (Measurement Start Time Setup)	23
5.2.2.6 MANUAL (Manual Setup)	25
5.2.3 P-BACK	26
5.2.4 CLEAR (Data Erase)	28
5.3 Memory Capacity	29
5.4 Reset Function	29
6. Power Supply	30
6.1 Turning the Power Off	30
6.1.1 Using Keys to Turn the Power Off	30
6.1.2 Turning the Power Off in Stop Mode	30
6.2 Battery Voltage Down	30
6.3 AC Adapter	31
6.4 Memory Backup	31

7. Error Messages and the Corrective Measures to Take	32
7.1 Overrange and Sensor Disconnection	32
7.2 Memory Shortage	32
8. Interface	33
8.1 Connecting to a PC	33
8.1.1 Connection by USB	33
8.1.2 Connection by RS-232C	33
8.2 Data Input	34
9. Maintenance	37
9.1 Storage	37
9.2 Case Cleaning	37
10. Precautions	38
11. Specifications	39
12. Appendix	41
12.1 Maximum Usage Time	41
12.2 Overview of Operation	41

1. Overview

1.1 Product Overview

The Compact Thermologger “AM-8000 Series” is a temperature measurement instrument with multichannel memory functions. Data from 6 or 12-channel thermocouple sensors and voltage inputs is stored in the Compact Thermologger internal memory. (Memory capacity: 60,000 data for the 6-channel version, 120,000 data for the 12-channel version)

The stored data can be transferred to a personal computer via USB1.1 or RS-232C and used for, e.g., producing graphs or tables. Furthermore, the Compact Thermologger supports a remote control function via PC, and thus can be variously controlled therefrom. (The related software is separately available from Anritsu Meter.)

Product model

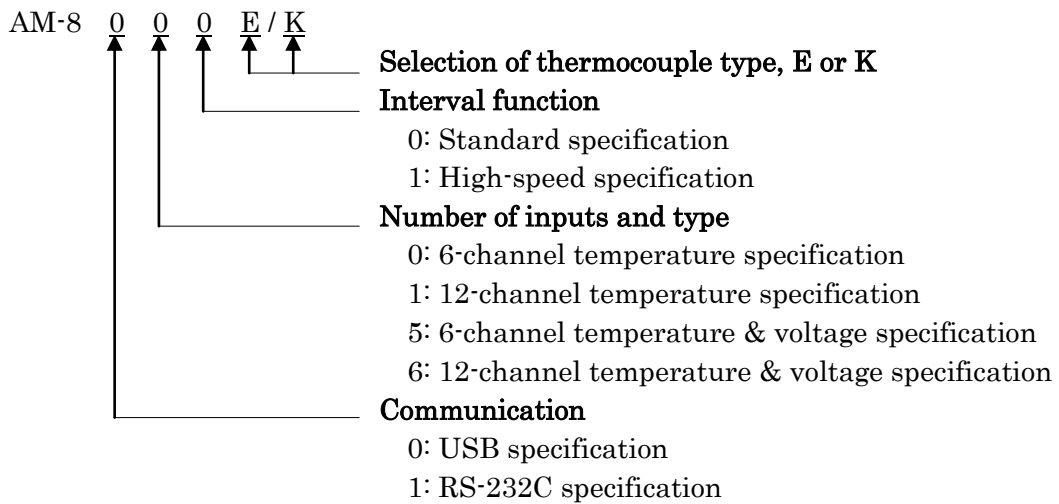

Communication mode: USB1.1

	6ch standard	6ch high-speed interval	12ch standard	12ch high-speed interval
Temperature	AM-8000 *	AM-8001 *	AM-8010 *	AM-8011 *
Temperature & voltage	AM-8050 *	AM-8051 *	AM-8060 *	AM-8061 *

Communication mode: RS-232C

	6ch standard	6ch high-speed interval	12ch standard	12ch high-speed interval
Temperature	AM-8100 *	AM-8101 *	AM-8110 *	AM-8111 *
Temperature & voltage	AM-8150 *	AM-8151 *	AM-8160 *	AM-8161 *

1.2 Features

① Simple operation

The Compact Thermologger is compactly built, displays the necessary measurement information on one screen, and offers simple, menu-based operation.

② Large-sized LCD

A 128 x 64 pixel LCD is used for information display, enabling the Compact Thermologger to show measurement data for 6 channels simultaneously.

③ High-speed sampling

The Compact Thermologger is capable of high-accuracy, high-speed sampling at a rate of 6 or 12 channels per second. (For high-speed interval specification, data can be sampled for 6 channels every 100 ms or for 12 channels every 200 ms.)

④ Low power consumption

For extended periods of long-interval measurements (2 seconds or more for 6 channels, 3 seconds or more for 12 channels), the Compact Thermologger supports sleep mode measurement in which power consumption is minimized. This feature allows for 10 consecutive days of measurement (based on a 25°C environment, alkaline cells, and a 10-minute measurement interval).

⑤ Large memory capacity

The large memory of the Compact Thermologger provides 60,000 data for 6 channels, or 120,000 data for 12 channels.

⑥ Inter-channel potential difference

A photo-MOS relay (solid state relay) is adopted for the multiplexer in the input section of the Compact Thermologger, enabling measurement to be performed unaffected by variations in the potential difference between channels (up to 60 V AC).

⑦ Selectable interface

For data transfer, USB1.1 and RS-232C interfaces are available. Select the one that suits to your operating environment.

⑧ Isolated communication lines

The communication signal lines feature photocoupler isolation, as well as other countermeasures, to prevent ground looping that would otherwise be created between the communication circuit and PC, which enables highly reliable measurement.

2. Unpacking

2.1 Unpacking Your Product

After opening the transportation box, check to see that all of the items listed below are included. Although the product was packed with utmost care, if any item is missing or faulty, please contact your distributor or Anritsu Meter.

Compact Thermologger main body	1
USB communication cable (USB model only)	1
RS-232C communication cable (RS-232C model only)	1
User’s manual (this book)	1 copy
Warranty card	1
Soft case	1
Alkaline AA-size battery	4

2.2 Repacking Your Product

When moving the Compact Thermologger (e.g., by car), be sure to use the case in which your product was packed. If the case is not at hand, thoroughly protect the Compact Thermologger with shock-absorbing material (e.g., expanded polystyrene).

Be sure to use a dry, dust-free packing material. If dust or moisture is present the Compact Thermologger may be damaged.

3. Preparing for Operation

3.1 Part Names

- External view of the 6-channel model



- ① Sensor input
- ② Display
- ③ Keyboard
- ④ DC jack and communication connector
- ⑤ Battery compartment

• External view of the 12-channel model



- ① Sensor input
- ② Display
- ③ Keyboard
- ④ DC jack and communication connector
- ⑤ Battery compartment

3.2 Description of Keys

Key name	Functional description
M E N U	Displays the main menu screen.
S T A R T	Available on a command wait screen, it starts measurement.
S T O P	Available during measurement, it terminates measurement.
D I S P	Available during measurement, it switches display modes.
E S C	Returns you to the command wait screen during menu setup.
ON	Turns the main power supply on.
OFF	Turns the main power supply off.
E N T E R	Confirms the item selected or the data keyed-in.
⤴ (Cursor key)	Moves the cursor upward. When altering a numeric value, it increments the value at the cursor position. When one-measuring-channel display mode is selected, it increments the display channel.
⤵ (Cursor key)	Moves the cursor downward. When altering a numeric value, it decrements the value at the cursor position. When one-measuring-channel display mode is selected, it decrements the display channel.
⤴ (Cursor key)	Moves the cursor to the left.
⤵ (Cursor key)	Moves the cursor to the right.

3.3 Power Supply

3.3.1 Installing Batteries

- 1) Open the battery compartment cover and insert dry batteries, noting polarity.
- 2) Close the cover.

【CAUTION】

Always turn the power off upon battery replacement.

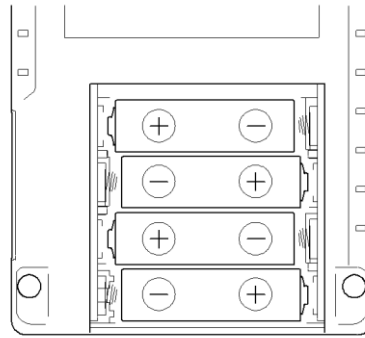

3.3.2 Using the AC Adapter

- 1) After turning the main body power switch off, connect the AC adapter jack to the main body, as shown below.
- 2) Connect the AC adapter plug to the mains outlet.

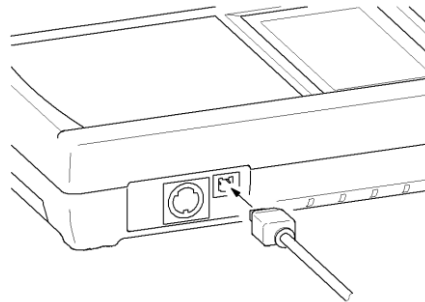

【CAUTION】

Even if the AC adapter is connected, but power is turned off, do not remove the batteries from the main body.
When the power switch is turned off, the memory backup power is supplied from the internal batteries.

3.4 Connecting Input Plugs

- 1) Check the polarity of any plugs to be connected. (Refer to the diagram below.)
- 2) Check the polarity of the corresponding input socket of the main body, and then insert the input plug into position, as shown below. (Positive is on the display side of the main body.)

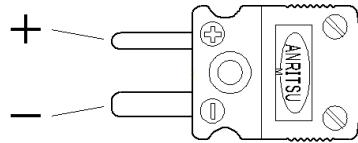
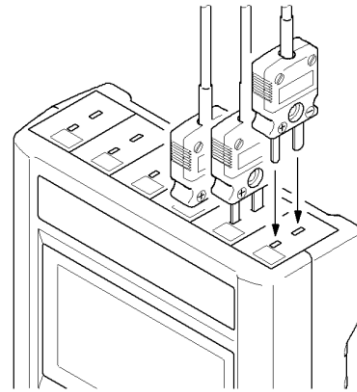

【CAUTION】

For the input plugs, always be sure to use the dedicated plugs separately available from Anritsu Meter (ANP series, exclusively for thermocouple/voltage input). Note that, as the Compact Thermologger models designed to the temperature & voltage composite specification (AM-8*5** and AM-8*6**) use a connector constructed of the same kind of metal as that of the thermocouple in the main body input part, the only other thermo-electromotive factor present during voltage measurement is the internal temperature distribution of the equipment, which is negligible as regards error generation.

4. Power-on and Initial Screen

4.1 Turning the Power On

When the Compact Thermologger has been prepared for operation, press the **ON** key to turn the power on, and the initial screen shown to the right will appear.

Display content

First and second lines: Product name

Third line: Product type and version
Number

Fourth line: Company name

```
COMPACT
      THERMO  LOGGER
AM-8051E  Ver. 1.0
ANRITSU  METER
```

<Initial screen (AM-8051E)>

About three seconds later, the display changes to a command wait screen (showing measurement conditions).

Display content

First and second lines: Date and time

Second line: Remaining amount of
memory, and machine number

Third line: Channels used and
measurement units

* The models designed to the
12-channel specification show
channels 1-6 and channels
7-12 alternately

Fourth line: Measurement interval

* The display varies with functions
and measurement mode.

```
04/12/01  12:00
      60000 free No.00
CH 1:c2:c3:c4:c5:c6:c
INTERVAL  00m01s
```

<Command wait screen>

【CAUTION】

If the power is turned on immediately after being turned off, the Compact Thermologger may operate erratically or display erroneous data. Therefore, wait 3 seconds or more before you turn the power back on again.

4.2 Description of the Indicated Symbols

Some of the symbols shown on the LCD display are simplified. The meanings of these simplified symbols are described below.

Displayed symbol	Description
00m01s	Represents minutes and seconds.
°C	Represents centigrade.
C	Represents centigrade.
V	Represents voltage.

5. Starting Measurement and Setting Each Item

From the command wait screen, you can perform one of three operations.

START key: Starts measurement at currently displayed intervals.
(See Section 5.1.1.)

MENU key: Sets intervals, calendar, and other items. (See Section 5.2.)

OFF key: Turns the power off.
(See Section 6.1.1.)

```
04/12/01 12:00
60000 free No.00
CH 1:c2:c3:c4:c5:c6:c
INTERVAL 00m01s
```

< Command wait screen >

5.1 Types of Measurements

The Compact Thermologger allows you to perform measurements in three modes: normal measurement, manual measurement, or real measurement.

In normal measurement, the Compact Thermologger records the measurement data at each set interval. (See Section 5.1.1.)

In manual measurement, the Compact Thermologger records the measurement data at specified intervals. (See Section 5.1.2.)

In real measurement, the Compact Thermologger sends the measurement data to a personal computer at each set interval while communicating with the personal computer in real time. (See Section 5.1.3.)

5.1.1 Normal Measurement

The Compact Thermologger is in normal measurement mode when the word "INTERVAL" is displayed on the command wait screen. Pressing the **START** key here causes the Compact Thermologger to start measurement, with the measurement data stored in memory at set intervals. During measurement, the Compact Thermologger shows the measurement data on a normal measurement screen or a one-selected-channel extended display screen.

Usable keys during normal measurement

STOP key: Terminates measurement and returns you to the command wait screen

DISP key: See the explanation below.

Each time you press the **DISP** key, the measurement screen is alternated between 1–6 channel data, one-selected-channel extended display, 1–6 channel data, and so on.

At this time, for the models designed to the 12-channel specification, the measurement screen is switched over in order of 1–6 channel data, 7–12 channel data, one-selected-channel extended display, 1–6 channel data, and so on. While in one-selected-channel extended display, use the **▲** and **▼** keys to select the channel you wish to display.

```

04/12/01 12:00
60000 free No.00
CH 1:c2:c3:c4:c5:v6:v
INTERVAL 00m01s
    
```

< Command wait screen >

↑
Displayed interval

Current time Remaining amount of memory

```

          ↓                ↓
          12:00           59994
          -----
1: 500.0c 2: 500.0c
3: 500.0c 4: 500.0c
5: 19.000v 6: 19.000v
    
```

< Normal measurement screen >

```

          12:00           59994
1: 500.0°C
    
```

< One-selected-channel extended display screen during normal measurement >

- For extended periods of long-interval measurements (2 seconds or more for 6 channels, 3 seconds or more for 12 channels), the Compact Thermologger performs measurement in sleep mode. In sleep mode, although operations and display on the Compact Thermologger are unchanged, communications with external equipment is disabled. For details on sleep mode, refer to paragraph (4) in Section 1.2. For details on communication, refer to the user's manual included with your dedicated PC software. (The dedicated PC software is separately available from Anritsu Meter.)
- If "INTERVAL" and "TIMER ON," is alternately displayed on the Interval section of the command wait screen, it means that the Compact Thermologger is set to normal measurement with a timer set. For details, refer to Section 5.2.2.5.
- If the interval display part shows "MANUAL," turn MANUAL measurement off by referring to Section 5.2.2.6.
- If a message "OVER" or "B-OUT" is displayed during measurement, refer to Section 7.1.
- If the remaining amount of memory reaches 0, measurement is aborted and "OUT OF MEMORY" is displayed. For details on how to proceed, refer to Section 7.2.

5.1.2 Manual Measurement

The Compact Thermologger is in manual measurement mode when the word “MANUAL” is displayed on the command wait screen. Each time you press the **START** key, the Compact Thermologger stores the measurement data in memory. During measurement, the Thermologger shows the measurement data on a manual measurement screen or a one-selected-channel extended display screen.

```

04/12/01 12:00
60000 free No.00
CH 1:c2:c3:c4:c5:v6:v
MANUAL
  
```

< Command wait screen >



Shows manual measurement

Usable keys during manual measurement

STOP key: Terminates measurement and returns you to the command wait screen

DISP key: See the explanation below.

Each time you press the **DISP** key, the measurement screen is switched between 1–6 channel data, and one-selected-channel extended display.

For models designed to the 12-channel specification, the order of display of the measurement screen follows the pattern 1–6 channel data, 7–12 channel data, one-selected-channel extended display, 1–6 channel data, and so on. While in one-selected-channel extended display, use the  and  keys to select the channel you wish to display.

Manual measurement	Remaining amount of memory
↓ <u>MANUAL</u>	↓ 59994
1: 500.0 c	2: 500.0 c
3: 500.0 c	4: 500.0 c
5: 19.000 v	6: 19.000 v

< Manual measurement screen >

```

MANUAL 59994
1: 500.0°C
  
```

< One-selected-channel extended display screen during manual measurement >

- If a message “OVER” or “B-OUT” is displayed during measurement, refer to Section 7.1.
- If the remaining amount of memory reaches 0, measurement is aborted and “OUT OF MEMORY” is displayed. For details on how to proceed, refer to Section 7.2.

5.1.3 Real Measurement

Connect the Compact Thermologger and personal computer. For more details on the connections method, refer to Chapter 8, "Interface."

After connection is made, start measurement using the dedicated PC software "real measurement" from the command wait screen (either interval or manual). In real measurement, data is not recorded in the internal memory of the Compact Thermologger. For details, refer to the user's manual of your dedicated PC software (The dedicated PC software is separately available from Anritsu Meter.).

During real measurement, do not press the keys on the Compact Thermologger.

Furthermore, since the voltage drain of the batteries during real measurement cannot be determined from the personal computer, try using the dedicated AC adapter as much as possible.

(The dedicated AC adapter is separately available from Anritsu Meter.)

If a message "OVER" or "B-OUT" is displayed during measurement, refer to Section 7.1.

```
04/12/01 12:00
60000 free No.00
CH 1:c2:c3:c4:c5:v6:v
INTERVAL 00m01s
```

< Command wait screen >

Real measurement

```
MANUAL REAL
1: 500.0c 2: 500.0c
3: 500.0c 4: 500.0c
5:19.000v 6:19.000v
```

< Real measurement screen >

5.2 Various Settings

You can perform simple check measurement (a special measurement), verify the data recorded in the internal memory, and make various settings that suit measurement conditions by, for example, setting memory erase or other functions, or altering the interval or calendar settings.

Pressing the **MENU** key on the command wait screen brings up the main menu (MAIN MENU) screen.

In MAIN MENU, you can select one of four modes: check measurement, measurement condition setup, recorded data playback display, or recorded data erasure display. Use the **◀**, **▶**, **▲**, and **▼** keys to select your desired item and press the **ENTER** key to confirm.

Cursor blinks

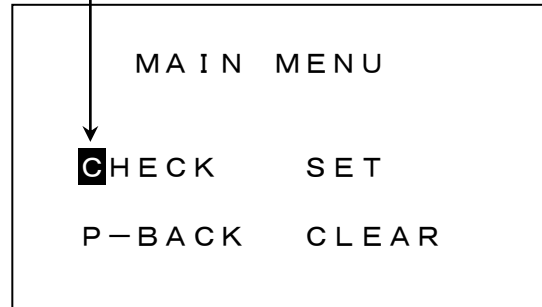

<Main menu screen>

ESC key: Returns you to the command wait screen.

OFF key: Turns the power off (see Section 6.1.1).

5.2.1 CHECK (Check Measurement)

This function allows you to perform a test measurement in which the measurement data is not recorded in memory.

On the main menu screen, place the cursor at the menu labeled “CHECK” and press the **ENTER** key to confirm.

The Compact Thermologger will start a test measurement. Note that test measurements are performed at a fixed interval of 1 second.

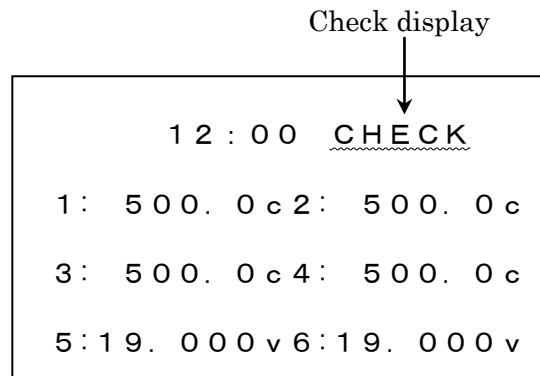

< Check measurement screen >

Usable keys during check measurement

STOP key: Terminates measurement and returns you to the command wait screen

DISP key: See the explanation below.

OFF key: Turns the power off (see Section 6.1.1).

Each time you press the **DISP** key, the measurement screen is switched between 1–6 channel data and one-selected-channel extended display.

For the models designed to the 12-channel specification, the measurement screen is switched over in order of 1–6 channel data, 7–12 channel data, one-selected-channel extended display, 1–6 channel data, and so on. While in one-selected-channel extended display, use the **▲** and **▼** keys to select the channel you wish to display.



< One-selected-channel extended display screen during check measurement >

- If a message “OVER” or “B-OUT” is displayed during measurement, refer to Section 7.1.

5.2.2 SET (Various Settings)

This function allows you to set measurement conditions.

On the main menu screen, place the cursor at the menu labeled "SET" and press the **ENTER** key to confirm. The screen will change to a measurement condition setup (CONDITION SET) screen.

Then, place the cursor at the item you wish to set and press the **ENTER** key to confirm.

Note that each time you finish setting an item, you are returned to the measurement condition setup screen. The contents you have set are stored in the internal memory.

Note that each time you finish setting an item, you are returned to the measurement condition setup screen. The contents you have set are stored in the internal memory.

ESC key: Returns you to the command wait screen.

MENU key: Returns you to the main menu screen.

OFF key: Turns the power off (see Section 6.1.1).

Cursor blinks



< Measurement condition setup screen >

5.2.2.1 CHANNEL (Channel Setup)

This function allows you to set the measurement mode for each channel.

On the measurement condition setup screen, place the cursor at the item labeled “CHANNEL” and press the **ENTER**

key to confirm. The screen will change to a channel setup (CHANNEL SET) screen.

Use the **◀** and **▶** keys to place the cursor at the channel you wish to set and then the **▲** and **▼** keys to switch between setup items.

When you have finished this setting, press the **ENTER** key to confirm.

Cursor blinks

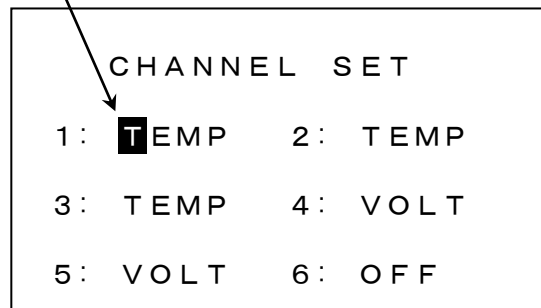

< Channel setup screen >

For models designed to the 12-channel specification, when you press the **ENTER** key after setting channels 1–6, the screen changes to a 7–12 channel setup screen.

Note that shown at the upper right is an example screen for the models designed to the temperature & voltage composite specification (AM-8*5** and AM-8*6**), in which channels are set for TEMP (temperature), VOLT (voltage), or OFF (unused).

For the models designed to the temperature specification (AM-8*0** and AM-8*1**), because measurements are made only for temperatures, channels are set for TEMP (used) or OFF (unused).

Note also that the data storage capacity per channel is the total storage capacity divided by the number of channels used. Therefore, select OFF for the unused channels.

ESC key: Returns you to the command wait screen.

MENU key: Returns you to the main menu screen.

OFF key: Turns the power off (see Section 6.1.1).

5.2.2.2 RESOL (Resolution Setup)

This function allows you to set the resolution of measurement.

On the measurement condition setup screen, place the cursor at the item labeled “RESOL” and press the **ENTER** key to confirm. The screen will change to a measurement resolution setup (RESOLUTION SET) screen.

Use the **◀** and **▶** keys to move the cursor and press the **ENTER** key to confirm.

Note that shown to the right is an example screen for the case where the type of thermocouple is E, K, J, or T.

If the type of thermocouple is R, the resolution is fixed.

Cursor blinks

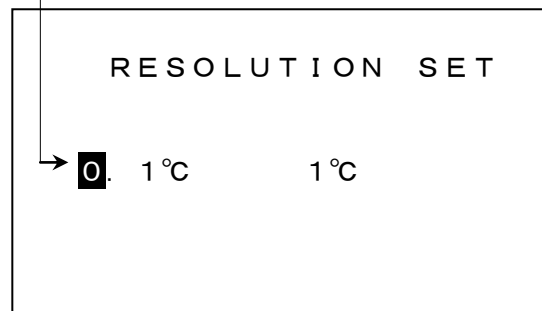

< Resolution setup screen >

If temperature measurement is outside the range of -105.0°C and 505.0°C with a resolution of 0.1°C, it is automatically changed to a 1°C resolution.

ESC key: Returns you to the command wait screen.

MENU key: Returns you to the main menu screen.

OFF key: Turns the power off (see Section 6.1.1).

5.2.2.3 INT&MNo (Interval and Machine No. Setup)

This function allows you to set measurement intervals and the machine number.

On the measurement condition setup screen, place the cursor at the item labeled “INT&MNo” and press the **ENTER** key to confirm. The screen will change to an interval and machine number setup (INTERVAL SET) screen.

Use the **◀** and **▶** keys to place the cursor at the value you wish to change and then the **▲** and **▼** keys to increment or decrement the value.

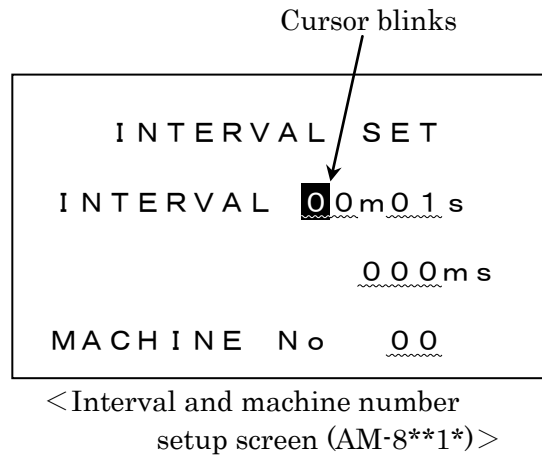

The measurement intervals that can be set for “INTERVAL” here differs with each Compact Thermologger model. Refer to the table shown in the next page.

Use “MACHINE No.” to discriminate particular Compact Thermologgers if you have more than one. (Machine Nos. from 00 to 99 can be set.)

ESC key: Returns you to the command wait screen.

MENU key: Returns you to the main menu screen.

OFF key: Turns the power off (see Section 6.1.1).

• Measurement Interval Setup Range

	High-speed interval	Standard interval
AM-8*00 AM-8*50 AM-8*10 AM-8*60	/	1 second to 99 minutes 59 seconds in 1-second increments
AM-8*01 AM-8*51	100 ms to 990 ms in 10-ms increments	1 second to 99 minutes 59 seconds
AM-8*11 AM-8*61	200 ms to 990 ms in 10-ms increments	in 1-second increments

* High-speed and normal modes can be changed by entering “00m00s” for normal mode or “000ms” for high-speed mode and then pressing the **ENTER** key.

5.2.2.4 CLOCK (Date and Time Setup)

This function allows you to set the date and time of day (calendar).

On the measurement condition setup screen, place the cursor at the item labeled "CLOCK" and press the **ENTER** key to confirm. The screen will change to a calendar setup (CLOCK SET) screen.

The second and the third lines of the screen show the date (year/month/day) and the time (hours/minutes), respectively.

Use the **←** and **→** keys to place the cursor at the value you wish to change and then the **▲** and **▼** keys to increment or decrement the value.

When you have finished, press the **ENTER** key to confirm.

Cursor blinks

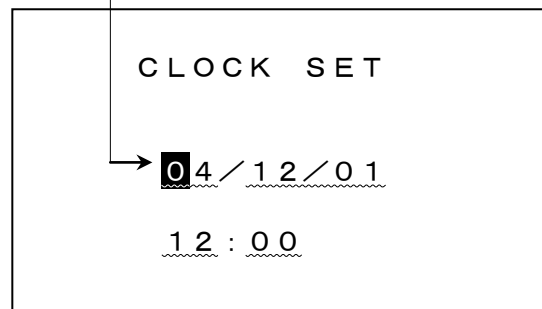

< Calendar setup screen >

- ESC** key: Returns you to the command wait screen.
- MENU** key: Returns you to the main menu screen.
- OFF** key: Turns the power off (see Section 6.1.1).

5.2.2.5 TIMER (Measurement Start Time Setup)

This function allows you to set up the timer or clear timer settings.

Set the time until start of measurement in units of minutes, from 0 to 99. The set time is then counted-down on the screen until the start of measurement.

① Setting the timer

On the measurement condition setup screen, place the cursor at the item labeled “TIMER” and press the **ENTER** key to confirm. The screen will change to a timer setup (START TIME SET) screen.

Use the **◀** and **▶** keys to place the cursor at “ON” (or “OFF” to clear settings) and press the **ENTER** key to confirm. The timer time setup screen will be displayed.

Cursor blinks



< Timer setup screen >

On the timer time setup screen, use the **◀** and **▶** keys to place the cursor at the value you wish to change and then the **▲** and **▼** keys to increment or decrement the value. When you have finished the setting, press the **ENTER** key to confirm.

Cursor blinks

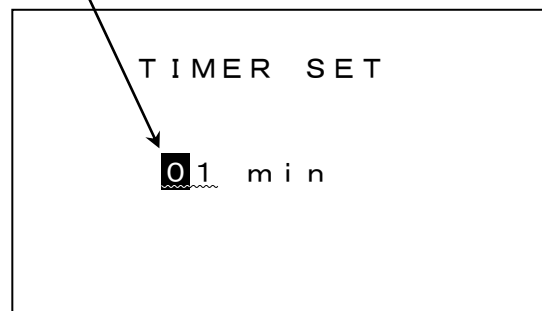

< Timer time setup screen >

ESC key: Returns you to the command wait screen.

MENU key: Returns you to the main menu screen.

OFF key: Turns the power off (see Section 6.1.1).

② Executing the timer

When the timer is turned “ON,” the normal screen and the one shown to the right (i.e., INTERVAL and TIMER ON) are displayed alternately in a command wait state.

While in this state, press the **START** key. The Compact Thermologger will start counting down simultaneously upon pressing the key, and shows a count-down timer display screen until the measurement start time is reached.

When the timer reaches zero, normal measurement starts.

For details on normal measurement, refer to Section 5.1.1.

If manual measurement has been set, priority is given to manual measurement and the timer is ignored. For details on manual measurement, refer to Section 5.1.2.

```
04 / 12 / 01 12 : 00  
60000 free No. 00  
CH 1 : c2 : c3 : c4 : c5 : c6 : c  
TIMER ON
```

< Command wait screen
during timer setup >

```
04 / 12 / 01 12 : 00  
  
01 : 00
```

< Count-down timer display screen >

5.2.2.6 MANUAL (Manual Setup)

This function allows you to select or deselect manual measurement. For details on manual measurement, refer to Section 5.1.2.

On the measurement condition setup screen, place the cursor at the item labeled “MANUAL” and press the **ENTER** key to confirm. The screen will change to a manual setup (MANUAL SET) screen. Use the **◀** and **▶** keys to place the cursor at “ON” (or “OFF” to clear settings) and press the **ENTER** key to confirm.

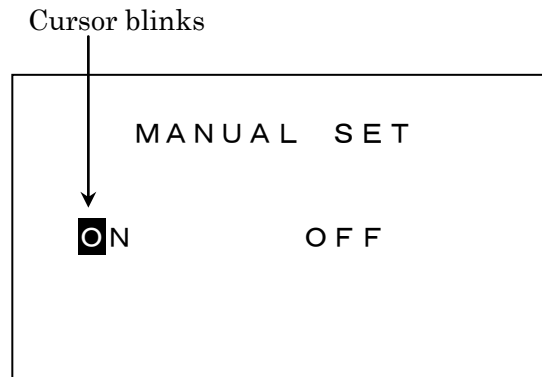

<Manual setup screen>

ESC key: Returns you to the command wait screen.

MENU key: Returns you to the main menu screen.

OFF key: Turns the power off (see Section 6.1.1).

5.2.3 P-BACK

This function searches for the measurement data recorded in memory and reproduces it for display on the screen.

On the main menu screen, place the cursor at the menu labeled “P-BACK” and press the **ENTER** key to confirm. The screen will change to a playback setup (PLAY BACK) screen.

Use the **◀** and **▶** keys to place the cursor at the value you wish to change and then the **▲** and **▼** keys to increment or decrement the value.

When you have finished the setting, press the **ENTER** key to confirm.

The Compact Thermologger will start searching for data and reproduces the measurement data for display on the screen.

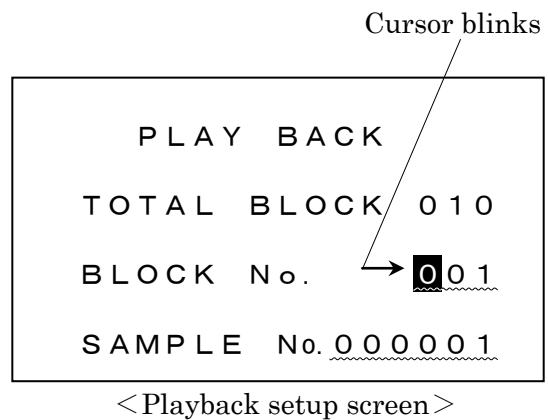

ESC key: Returns you to the command wait screen.

MENU key: Returns you to the main menu screen.

OFF key: Turns the power off (see Section 6.1.1).

“TOTAL BLOCK” :

This shows the total number of data blocks recorded in the internal memory of the Compact Thermologger.

“BLOCK No.” :

This is the number assigned to data in block units, with one block comprised of a length of data from when measurement started (**START** key) until when measurement finished (**STOP** key).

Specify a block number you wish to be reproduced for display on the screen.

“SAMPLE No.” :

Specify a block number you wish to be reproduced for display on the screen.

The following explains the operations performed by the respective keys on the playback data display screen.

- ▲ key: Shows the next data
- ▼ key: Shows the previous data.
- ▶ key: Shows the next data at high speed.
- ◀ key: Shows the previous data at high speed.

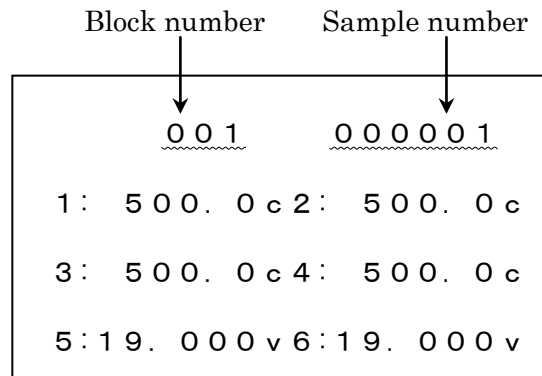

< Playback data display screen >

- ESC key: Returns you to the playback setup screen.
- MENU key: Returns you to the main menu screen.
- DISP key: See the explanation below.
- OFF key: Turns the power off (see Section 6.1.1).

Pressing the DISP key brings up a playback measurement condition screen showing the conditions under which the data presently being reproduced was obtained.

Each time you press the DISP key, the content shown on this screen is switched over in order of data, measurement conditions, data, and so on.

For models designed to the 12-channel specification, the content shown on this screen is switched over in order of 1–6 channel data, 7–12 channel data, measurement conditions, 1–6 channel data, and so on.

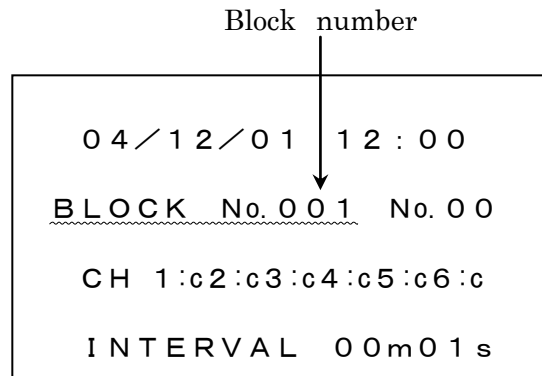

< Playback measurement condition screen >

The items displayed on the measurement condition screen here, except the block No., are the same as those shown on the command wait screen. Note also that the respective keys on this screen have the same functions as on the playback data display screen described above.

5.2.4 CLEAR (Data Erase)

This function erases all of the data recorded in the internal memory of the Compact Thermologger.

On the main menu screen, place the cursor at the menu labeled “CLEAR” and press the **ENTER** key to confirm. The screen will change to a clear operation select (CLEAR) screen.

Use the **◀** and **▶** keys to place the cursor at “OK” (or “CANCEL” to cancel) and press the **ENTER** key to confirm.

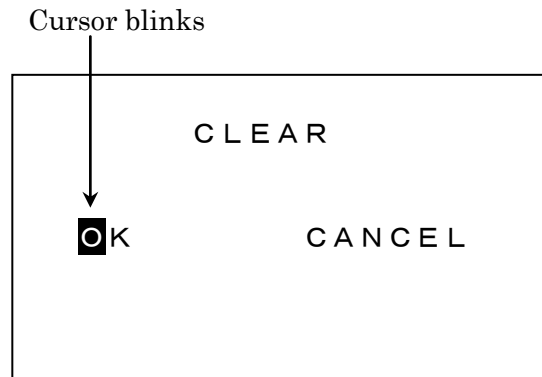

< Clear operation select screen >

ESC key: Returns you to the command wait screen without erasing data.

MENU key: Returns you to the main menu screen without erasing data.

OFF key: Turns the power off (see Section 6.1.1).

* Note that once cleared, data cannot be recovered.

5.3 Memory Capacity

The Compact Thermologger has a memory area consisting of 999 blocks for storing setup data, in addition to a memory area for storing measurement data. If the measurement file exceeds 999 blocks, measurement stops.

If the remaining amount of memory in the Compact Thermologger reaches 0, measurement is aborted and an out of memory screen is displayed. Although you can return to the command wait screen by pressing the **ENTER** key, you can no longer perform normal and manual measurements.

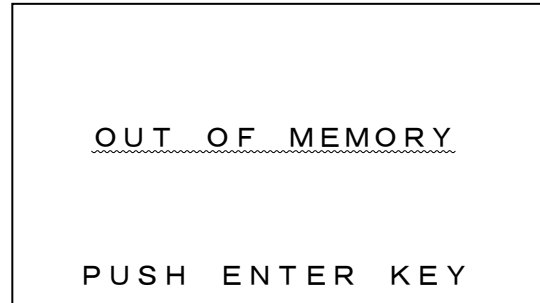

< Out of memory screen >

If you wish to proceed and perform normal or manual measurement, erase the recorded data from the Compact Thermologger after saving the data to your computer or taking other appropriate measures.

To save data to your computer, use “Data Input” of the dedicated PC software. For details, refer to Chapter 8, “Interface,” and the user’s manual included with your dedicated PC software. (The dedicated PC software is separately available from Anritsu Meter.)

For details on how to erase data from the internal memory, refer to Section 5.2.4.

5.4 Reset Function

If the Compact Thermologger operates erratically or you wish to reset various setup values to the initial state, hold down the **ENTER** key while pressing the **ON** key to turn the power on. In this case, a buzzer will sound twice in succession after an ordinary power-on sequence, and the internal memory of the Compact Thermologger will reset to the factory default.

* The calendar setup value is not altered.

6. Power Supply

6.1 Turning the Power Off

6.1.1 Using Keys to Turn the Power Off

Pressing the **OFF** key brings up a power-off confirmation screen.

Use the **◀** and **▶** keys to place the cursor at “OK” and press the **ENTER** key to confirm. The power will be turned off.

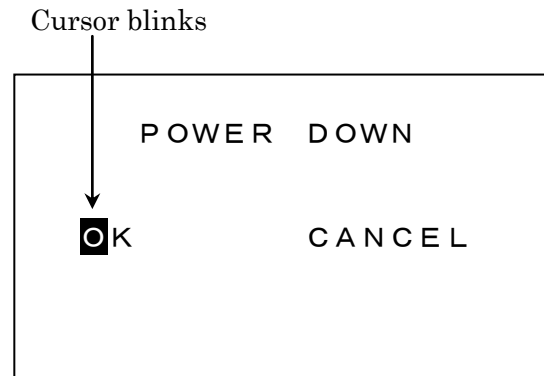

< Power-off confirmation screen >

6.1.2 Turning the Power Off in Stop Mode

If you continue using the Compact Thermologger after it indicates a power-down state (see Section 6.2), the power supply voltage will drop to a level at which measurement can no longer be taken. In this case, the Compact Thermologger enters CPU stop mode. In this mode, all operations are halted and the Compact Thermologger is automatically placed in a power-off state to protect the data recorded in memory.

6.2 Battery Voltage Down

If the batteries in the Compact Thermologger are drained causing the battery voltage to drop, the Compact Thermologger indicates a low battery state by displaying a battery mark (**B**) at the upper left corner of the screen, as shown to the right. Replace the batteries as soon as possible, taking care to turn the power off before doing so.

Battery state indicated here

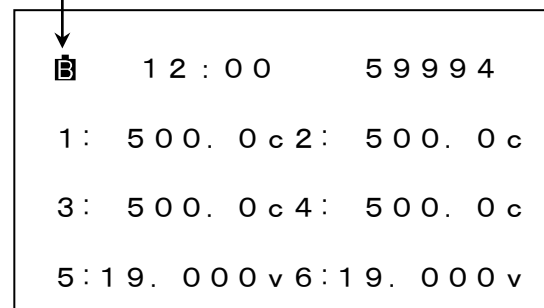

< Low battery display >

【CAUTION】

If the batteries need to be replaced during measurement, connect the AC adapter power supply to the Compact Thermologger before doing so. If you remove the batteries with no power supplied to the Compact Thermologger from the AC adapter, measurement will cease, and the data in memory may be corrupted.

6.3 AC Adapter

To perform measurement over a long time, or for real measurement, we recommend using the AC adapter to supply power for the Compact Thermologger.

Even when using the AC adapter, we recommend that batteries be installed. This is because if the AC power supply is cut while using the AC adapter, the power supply is switched to the batteries, and if none are present the memory contents will be lost.

Note, however, that if the Compact Thermologger is powered from batteries while it has the AC adapter connected, because a circuit to prevent current from flowing back to the batteries is actuated, the Compact Thermologger will be placed in stop mode in about 1/5 of the ordinary time (see Section 6.1.2), with the result that measurement is aborted. The Compact Thermologger main body cannot be turned on or off by simply turning the AC power supply via the AC adapter on or off.

6.4 Memory Backup

When the Compact Thermologger has batteries of sufficient voltage installed, the memory contents (recorded data and calendar and other setup contents) are retained.

Note, however, that even while the power is turned off, the Compact Thermologger still draws a very small current. Therefore, do not leave the recorded data stored in memory for a long period of time (with new batteries, for one month or more) or if the batteries in the Compact Thermologger have been drained to a stop mode level (see Section 6.1.2). Transfer the data to your computer as soon after collecting data as possible (see Chapter 8).

With no power from either AC or batteries, memory will be retained for 30 minutes. If the Compact Thermologger is placed in stop mode and the data stored therein cannot be transferred, immediately replace the batteries.

If no batteries are installed and the Compact Thermologger is operated with only the AC adapter, memory contents will not be retained once the AC power supply is shut down. Therefore, we recommend that the Compact Thermologger has batteries installed while in use.

7. Error Messages and the Corrective Measures to Take

7.1 Overrange and Sensor Disconnection

If measurement goes out of range or the sensor is disconnected, the Compact Thermologger shows “OVER” (for overrange) or “B-OUT” (for burn-out) on the screen. If the error message “OVER” is displayed, inspect whether the measurement values are within the valid range. If the error message “B-OUT” is displayed, inspect the sensor for loose or disconnected wires.

Overrange display Burn-out display

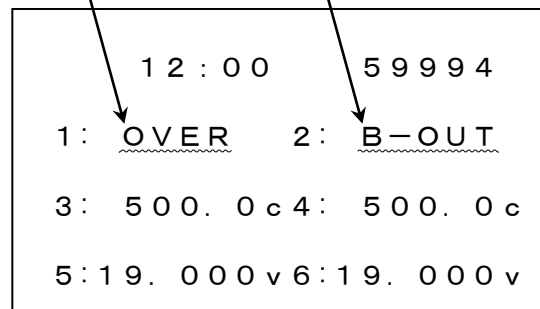

<Overrange and burn-out display>

* If a disconnection occurs in the probe during voltage measurement, the Compact Thermologger shows the readout value near 0 V, instead of “B-OUT.”

7.2 Memory Shortage

If the remaining amount of memory in the Compact Thermologger reaches 0, measurement is aborted and an out of memory screen is displayed. The command wait screen can be returned to by pressing the **ENTER** key, but normal and manual measurements cannot be performed.

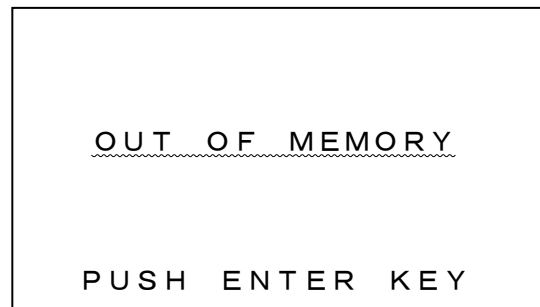

<Out of memory screen>

If you wish to continue taking measurements, erase the recorded data from the Compact Thermologger after saving the data to computer or taking other appropriate measures.

To save data to computer, use “Data Input” of the dedicated PC software. For details, refer to Chapter 8, “Interface,” and the user’s manual included with your dedicated PC software. (The dedicated PC software is separately available from Anritsu Meter.)

For details on how to erase data from the internal memory, refer to Section 5.2.4.

8. Interface

8.1 Connecting to a PC

8.1.1 Connection by USB

Use a USB communication cable which has a USB A plug on the PC side and USB mini-B 5-pin plug on the Compact Thermologger side. For connection to the PC side, plug the cable into the connector marked with  .

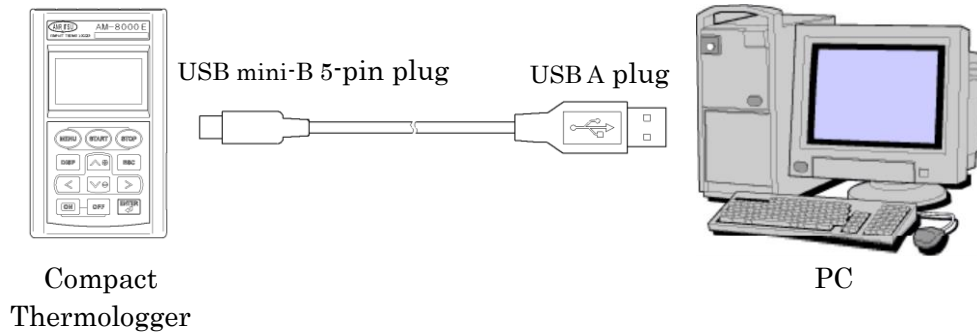

8.1.2 Connection by RS-232C

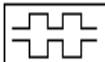
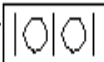
For connection to the PC side, plug the RS-232C cable into the connector marked with  or  .

* Be aware that the pin assignment of serial port connectors may vary according to computer.

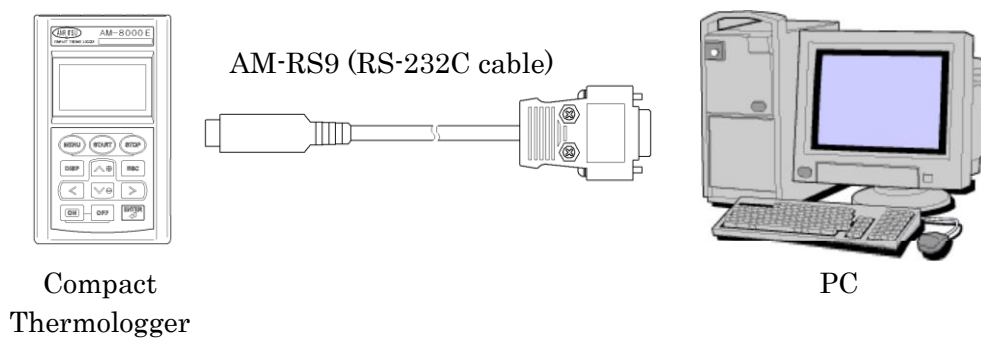

【CAUTION】

For details on the communication connectors on the PC, consult the user's manual included with your PC software, etc.

If the Compact Thermologger does not need to communicate with the PC, be sure to isolate it from the PC (by removing the communication cable).

If the Compact Thermologger remains connected to the PC while you run other application software on the PC, the Compact Thermologger may operate erratically or malfunction.

8.2 Data Input

This function creates a file and stores data from the Compact Thermologger memory in it.

- ① Confirm that the Compact Thermologger and a PC are connected correctly, and then turn the power to the Compact Thermologger on.
- ② Launch the dedicated PC software AMS-850 (separately available).
From the Communication menu, select the port on the PC that you wish to use for communication. When using USB, select USB.

* For details on how to install the PC software, and how to set up the USB driver or RS-232C communication port, refer to the user's manual of your PC software.

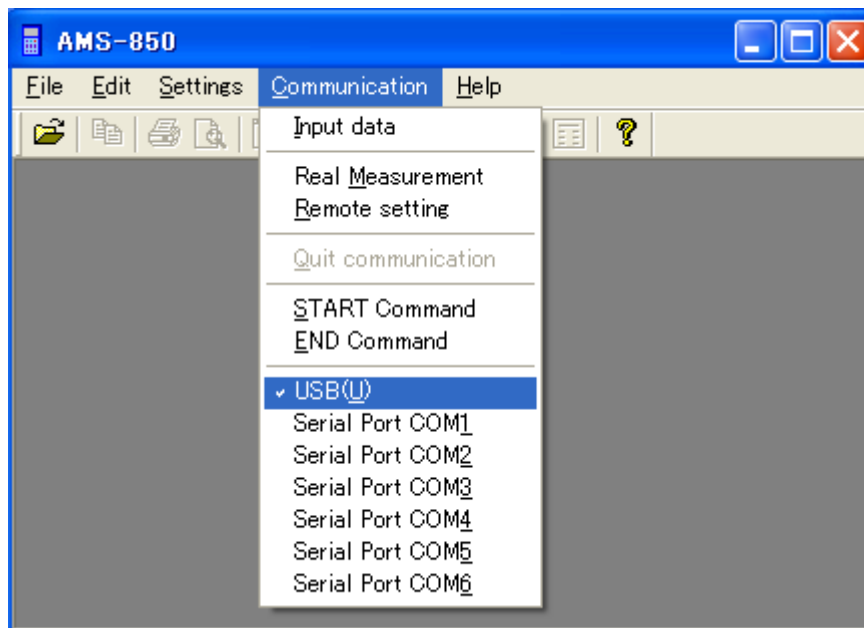

- ③ From the Communication menu, select Data Input.

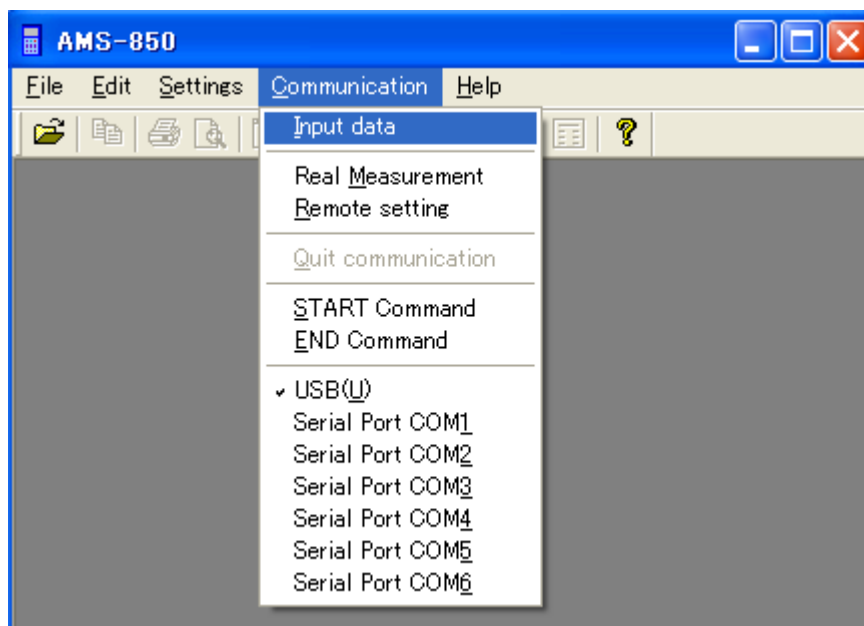

- ④ Specify the folder in which you wish to save the data, and click OK.

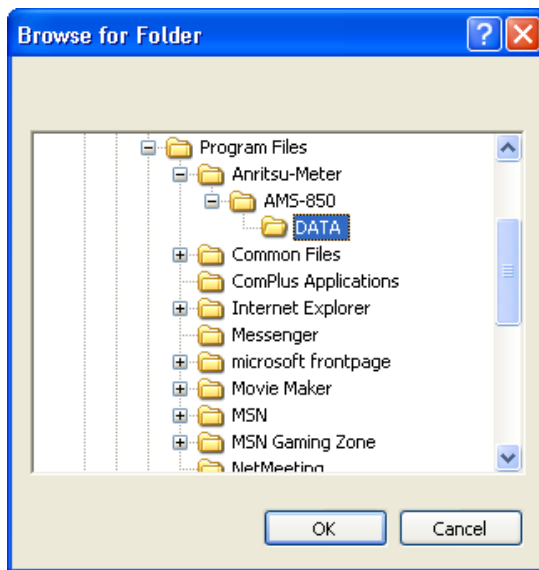

During communication, a transfer bar is displayed as shown below, allowing you to confirm the progress of data transfer. Pressing Interruption here causes the communication to stop, and no files are created.

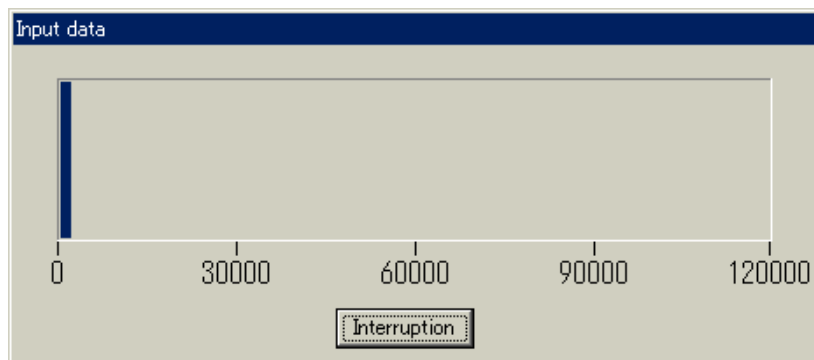

- * Do not press any keys on the Compact Thermologger during communication, as doing so will terminate transfer and may cause a malfunction.
- * Since the data in the Compact Thermologger is retained even after you selected to run Data Input, if a communication error, etc. occurs during communication, reselect Data Input.

When Data Input finishes and all data has been transferred, the newly created data file is displayed.

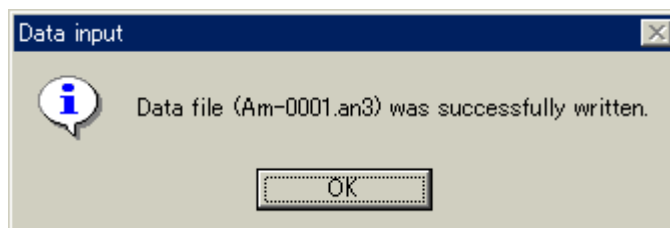

【CAUTION】 File names

The files are named “Am-****.an3,” where the **** part denotes a number assigned for each directory, from 0001 to 9999. Even when a file is deleted, all other file numbers remain unchanged.

For example, if when files up to the number 9999 are saved on the hard disk, files from 0001 to 9998 are deleted, the file with the number 9999 remains intact. In this case, because the file with the largest number (9999) remains saved, no more data can be saved in the directory containing this file.

If new data needs to be stored in this directory, rename the file or take other appropriate measures.

Example:

Change the name “Am-9999.An3” to “Am-0001.An3.”

For details on the PC software, refer to the user’s manual for the AMS-850 (separately available).

9. Maintenance

9.1 Storage

When storing the Compact Thermologger, avoid the following conditions:

- Exposure to direct sunlight
- Strong vibration
- High humidity (90% R.H. or higher)
- High temperatures (50°C or higher)
- Environment containing dust, dirt, corrosive gas, or salt
- Strong electromagnetic fields

If the Compact Thermologger is to be kept in storage over a long period, we recommend placing it in the packing box in which it was delivered. Also, because there is a possibility of liquid leakage, remove the batteries beforehand.

9.2 Case Cleaning

If the case of the Compact Thermologger becomes dirty, gently wipe clean with a damp cloth (water). Do not use solvents such as alcohol, thinner or benzene, as this will discolor the case or keypad of the Compact Thermologger.

10. Precautions

- To perform normal measurement (sleep mode measurement) over long time periods, always be sure to use new batteries.
- If the AC power supply goes down while using the AC adapter, the power for the Compact Thermologger is supplied from the batteries installed. In this case, however, the supply voltage to the internal circuit decreases by about 0.7 V because a circuit to prevent current from flowing back to the batteries is actuated, and the Compact Thermologger will be placed in CPU stop mode in about 1/5 of the ordinary time (with OFF displayed on the screen). If this condition occurs, the operation of the Compact Thermologger will not be recovered even when the AC power supply is restored, unless you turn the main body switch on (by turning it off briefly and then on again).

For details on how to back up the recorded data in the internal memory, refer to Section 6.1.2, “Turning the Power Off in Stop Mode,” and Section 6.4, “Memory Backup.”

- If no batteries are installed and the Compact Thermologger is operated with only the AC adapter, memory contents will not be retained if the AC power supply is turned off.

Furthermore, even when the power is restored, the operation of the Compact Thermologger will not be recovered unless you turn the main body power switch on (by turning it off briefly and then on again). This means that the main body cannot be turned on or off by simply turning the AC power supply on or off.

11. Specifications

• 6-channel model

Type	AM-8000*	AM-8001*	AM-8100*	AM-8101*	AM-8050*	AM-8051*	AM-8150*	AM-8151*
Number of input points	6 points: ANP connector (input with the same kind of metal as that of thermocouple)							
Type of input	Thermocouple: By type E, K, J, T, or R (J, T, and R are optional)				Thermocouple: By type E, K, J, T, or R (J, T, and R are optional) / Voltage			
Measurement range	See Table 1				Temperature: See Table 1 DC Voltage: ± 19.999 V			
Resolution	0.1°C/1°C (fixed)				Temperature: 0.1°C/1°C (fixed) DC Voltage: 0.001 V			
Measurement accuracy	See Table 2				Temperature: See Table 2 Voltage: 0.06% of \pm readout value + 0.02% of measurement range			
Memory capacity	60,000 data							
High-speed interval	1sec	0.1sec	1sec	0.1sec	1sec	0.1sec	1sec	0.1sec
Communication	USB1.1		RS-232C		USB1.1		RS-232C	
External dimensions	92 (W) x 155 (H) x 36 (D) mm, not including protrusions							
Weight	App. 380 g (including dry batteries)							

Note: The asterisk (*) in Type denotes the type of thermocouple (E, K, J, T, or R).

• 12-channel model

Type	AM-8010*	AM-8011*	AM-8110*	AM-8111*	AM-8060*	AM-8061*	AM-8160*	AM-8161*
Number of input points	12 points: ANP connector (input with the same kind of metal as that of thermocouple)							
Type of input	Thermocouple: By type E, K, J, T, or R (J, T, and R are optional)				Thermocouple: By type E, K, J, T, or R (J, T, and R are optional) / Voltage			
Measurement range	See Table 1				Temperature: See Table 1 DC Voltage: ± 19.999 V			
Resolution	0.1°C/1°C (fixed)				Temperature: 0.1°C/1°C (fixed) DC Voltage: 0.001 V			
Measurement accuracy	See Table 2				Temperature: See Table 2 Voltage: 0.06% of \pm readout value + 0.02% of measurement range			
Memory capacity	120,000 data							
High-speed interval	1sec	0.2sec	1sec	0.2sec	1sec	0.2sec	1sec	0.2sec
Communication	USB1.1		RS-232C		USB1.1		RS-232C	
External dimensions	96 (W) x 160 (H) x 60 (D) mm, not including protrusions							
Weight	App. 480 g (including dry batteries)							

Note: The asterisk (*) in Type denotes the type of thermocouple (E, K, J, T, or R).

• Common specifications

Reference junction compensation accuracy	$\pm 0.3^{\circ}\text{C}$ (at $25^{\circ}\text{C} \pm 10^{\circ}\text{C}$)
Temperature coefficient	$\pm(0.1\%/^{\circ}\text{C})$ of measurement range at other than $25^{\circ}\text{C} \pm 10^{\circ}\text{C}$
Measurement interval	Standard mode: 1 sec. to 99 min. 59 sec. High-speed mode: 0.1–0.99 sec. for 6-channel mode, or 0.2–0.99 sec. for 12-channel model
Signal source resistance	Temperature: $500\ \Omega$ or less (standard mode), or $100\ \Omega$ or less (high-speed mode) Voltage: Input impedance app. $2\ \text{M}\Omega$ or less
Permissible applied voltage	Between input pins on same channel: $\pm 10\ \text{V DC}$ (temperature), or $\pm 30\ \text{V DC}$ (voltage) Between input pins on adjacent channels: $\pm 60\ \text{V AC}$
Linearizer	Digital linearizer method (compliant with JIS C1602-1995)
Communication	USB1.1 MINI-B / RS-232C (selected at purchase)
Display method	Graphic liquid crystal display, 128 x 64 dots (55 x 27 mm)
Operating environment	0 to 40°C , 20 to 80%RH (non-condensing)
Storage environment	-10 to 50°C , 10 to 90%RH (non-condensing)
Power supply	Alkaline AA-size dry battery x 4 (included) or dedicated AC adapter (separately available)
Accessories	Alkaline AA-size dry battery x 4, user's manual, soft case, communication cable (USB or RS-232C)
Separately sold items	Dedicated AC adapter, dedicated data analysis software (AMS-850), carrying case

Table 1: Measurement Range

Thermocouple type	1°C resolution	0.1°C resolution
Type E	-200 to 800°C	-100.0 to 500.0°C
Type K	-200 to 1370°C	
Type J	-200 to 1100°C	
Type T	-200 to 400°C	-100.0 to 400.0°C
Type R	0 to 1760°C	Fixed to 1°C resolution

Table 2: Measurement Accuracy (not including reference contact correction accuracy, at $25^{\circ}\text{C} \pm 10^{\circ}\text{C}$)

Thermocouple type	Resolution	Measurement range	Measurement accuracy
Type E·K·J·T	1°C	0°C or above	$\pm(0.1\%$ of readout value + $1^{\circ}\text{C})$
		-100 to -1°C	$\pm(0.5\%$ of readout value + $1^{\circ}\text{C})$
		-101 to -201°C	$\pm(1\%$ of readout value + $2^{\circ}\text{C})$
	0.1°C	0.0°C or above	$\pm(0.1\%$ of readout value + $0.3^{\circ}\text{C})$
		-100.0 to -0.1°C	$\pm 0.5^{\circ}\text{C}$
Type R	1°C	0 to 1760°C	$\pm(0.1\%$ of readout value + $3^{\circ}\text{C})$

12. Appendix

12.1 Maximum Usage Time

- The table below shows the approximate length of time for which the 6-channel model of the Compact Thermologger can be used continuously.
(When operated with alkaline AA-size dry batteries at 25°C typ.)

Set interval	0.1sec	1sec	10sec	10min
Usable time	App. 20 hours	App. 40 hours	App. 80 hours	App. 10 days

12.2 Overview of Operation

Membrane keys

Key name	Function
START	Starts measurement
STOP	Stops measurement
DISP	Switches over display *1
MENU	Shows main menu
ESC	Shows command wait screen
◀, ▶, ▲, ▼	Moves cursor or changes display data No. *2
▲, ▼	Increment/decrements value or switches over modes *3 • Changes displayed channels *4
ENTER	Confirms the selected item or set data

*1: Effective during measurement in any mode or only when displaying P-BACK data

*2: Effective only when displaying P-BACK data

*3: Effective only when setting measurement conditions

*4: Effective only during extended display when performing measurement

Measurement condition setup screen (CONDITION SET)

Item name	Function
CHANNEL	Sets channels used for measurement
RESOL	Sets measurement resolution
INT&MNo	Sets measurement intervals and machine No.
CLOCK	Sets date and time
TIMER	Sets measurement start time
MANUAL	Sets up manual mode

Main menu screen (MAIN MENU)

Menu name	Function
CHECK	Performs check measurement
SET	Displays measurement condition setup
P-BACK	Reproduces measurement data
CLEAR	Erases measurement data

- Note that if you turn the power on while holding down the **ENTER** key, the set data for measurement conditions, etc. and the measurement data will all be erased.
- To erase the measurement data, use the CLEAR command on the main menu.
- For check measurement, measurement intervals are by default set to 1 second. The measurement data is not recorded in memory.
- The REAL mode settings of the Compact Thermologger are cleared when the power is turned off. All other mode settings are retained even when the power is turned off.
- Manual measurement does not depend on the measurement intervals you set, and the measurement data is recorded in memory manually.
- The Compact Thermologger functions except DISP, CHECK, and P-BACK can be set up and controlled under remote control from a personal computer.