

Instruction Manual
High accuracy
Handheld Thermometer

HRM-150E

First edition (Jan. 2024)

AE-100303

Anritsu Meter Co., Ltd.



2-4-5 Shimomeguro, Meguro-ku, Tokyo, 153-0064, Japan

TEL: +81-3-3491-9181

FAX: +81-3-3493-6729

Safety information

Caution

To safely operate and service the thermometer and to prevent any product damage and/or maintain the precise temperature measurement results, please carefully follow the instructions below:

- Do not use this product for any purpose other than taking temperature measurements.
- If any abnormalities are found, immediately stop using the product.
- Do not disassemble or modify the product.
- Do not use any power supply other than commercially available dry batteries and/or a dedicated adaptor.
- Insert the batteries in the correct manner (pole+ to pole+).
- Remove the batteries when depleted or when the product is not expected to be used for an extended period of time.
- Do not mix old and new batteries or batteries of different makes or types.

Warning

- Do not throw into an open fire. Do not short circuit, disassemble, or heat.
- Do not recharge the batteries at any time.
- Use specified type batteries.
- To prevent electric shock, do not touch the metal parts or terminals of the sensor cable or output cable during measurement.
- To prevent electric shock, if the sensor is still in contact with the voltage application part even when the power is turned off, disconnect the sensor before setting the output cable or device.
- ※ When measuring under the influence of high voltage and high frequency, there is a risk of electric shock and measurement failure, so please contact us.

Compliance

This product has a built-in reader/writer module that uses radio waves with a transmission frequency of 13.56 MHz.

Compliance with NCC Rules

 CCAQ23LP0670T0

『取得審驗證明之低功率射頻器材,非經核准,公司、商號或使用者均不得擅自變更頻率、加大功率或變更原設計之特性及功能。

低功率射頻器材之使用不得影響飛航安全及干擾合法通信;經發現有干擾現象時,應立即停用,並改善至無干擾時方得繼續使用。

前述合法通信,指依電信管理法規定作業之無線電通信。

低功率射頻器材須忍受合法通信或工業、科學及醫療用電波輻射性電機設備之干擾。』

Compliance in Japan

Standard number: ARIB STD-T82

Designated type number: FC-20001

This product contains a reader/writer module that is certified with a designated type of radio wave, which is provided by the *Radio Law* of Japan. As a radio wave with a transmission frequency of 13.56 MHz is used, the product.

Introduction

Thank you very much for purchasing this Anritsu Meter product.

This instruction manual has been carefully prepared to ensure that the product can be used safely and securely.

Please carefully and thoroughly read this instruction manual, fully understand all the individual functions, and use the product properly.

Should you have any unclear issues or questions while operating the product, please refer to this instruction manual.

Notes

- The contents of this document and/or product specifications are subject to change without prior notice.
- Unauthorized reproduction of any part of this document is strictly prohibited.
- This instruction manual has been prepared with absolute care. Please free feel to contact our company or your retailer should you discover any omissions or mistakes.
- In no event is Anritsu Meter liable to anyone for any indirect, special, or consequential damages as a result of using this product.

Warranty and After-sales Service

• Warranty

This product has been submitted to strict tests and inspections prior to delivery. Anritsu Meter warrants this product to be free from defects in material and workmanship for a period of one (1) year from date of delivery. Should any failures arise due to defects during manufacture or accidents during transportation, please contact our company or your retailer. For any failures during the warranty period which are deemed our responsibility, we will exchange the necessary parts or carry out repairs at no cost.

However, the warranty will be considered to be voided (i.e., the customer pays for repairs) in the following cases:

- Failure due to a fire, earthquake, or any other force majeure.
- Failure due to misuse, abuse, and/or modification. (Please note that if the case of the product is opened or the screws are loosened, such an act will be regarded as a modification.)

Note: Our thermocouple probes are consumables and are not covered by the warranty.

- **After-sales Service**

- If you think the product is not correctly working, please refer to this instruction manual. Should any issue persist, please contact our company or your retailer.

- Repairs during the warranty period are subject to the content of the warranty sheet. Repairs after the warranty period has elapsed will be carried out only if such repairs recover and maintain the product functions.

- If there is a need to return the product for repair or calibration, please pack it in the original packaging that was used for delivery. If such packaging is not available, please enclose the product with sufficient cushioning material and return the product in a condition where no damage can be caused.

Table of Contents

1.	General	1
2.	Unpacking	1
2.1.	Unpacking.....	1
2.2.	Repacking	1
3.	Name and Explanation of Each Part	2
3.1.	External View	2
3.2.	LCD Display	3
4.	Preparations Before Taking Measurements	4
4.1.	How to Install the Batteries.....	4
4.2.	How to Use the Hand Strap	4
4.3.	How to Use the AC Power Supply.....	5
4.4.	How to Set the Probe.....	5
4.5.	How to Use the Soft Case.....	5
5.	Operations and Functions	6
5.1.	Power ON/OFF	6
5.2.	Automatic correction function.....	6
5.3.	HOLD Function	7
5.4.	Automatic Power OFF Function	7
5.5.	Resolution Change.....	8
5.6.	P/V Hold Function	9
5.7.	Turning the Backlight ON/OFF	9
6.	Time Setting	10
7.	Memory Function	11
7.1.	Interval Setting	11
7.2.	Starting Memory Measurements	12
7.3.	Memory Play back Function.....	13
7.4.	How to clear the Data.....	14
8.	Dedicated Software AMS-350	15
8.1.	USB Connection	15
8.2.	How to Transfer Data in the Measuring Instrument	16
9.	Retention of Setup Data	18
10.	Checking the Remaining Battery	19
11.	Error Messages	20
11.1.	Indication of a Broken Wire of the Probe.....	20
11.2.	Overrange Indication	20

11.3.	Battery Voltage Drop Indication	20
12.	Maintenance	21
12.1.	Storage	21
12.2.	When the Case of the Instrument Gets Dirty.....	21
13.	Troubleshooting: Before Contacting Support.....	22
14.	HRM-150E Specifications	24

1. General

This product is a handheld thermometer for high accuracy, reliability and usability. Based on the HR Series, this product is highly accurate and supports probes with an IC tag. The IC tag records errors unique to thermocouple probes. By reading the IC tag, errors will be automatically corrected, thereby enabling even higher accuracy measurements.

By using the memory function, measured data can be stored in the memory and transferred to a PC.

Stored data will not be deleted even if the batteries in the main unit are fully depleted, thereby securely retaining data.

2. Unpacking

2.1. Unpacking

Please check if the following items are present when unpacking. We make sure all items are carefully packed, but should you find any missing or failed items, please contact our company or your retailer.

Item	Q'ty
Main unit	1
Soft case	1
Hand strap	1
USB cable	1
Dedicated software (AMS-300)	1
Alkaline AA battery	4
Instruction manual	1
Test report	1
Warranty sheet	1
User registration sheet	1

2.2. Repacking

To move this instrument (such as transportation by car), pack it in its original packaging. If the case is not available, fully protect the instrument with shock-absorbing material (Styrofoam, etc.). Please note that if packing materials generate dust or moisture, the instrument may become damaged. Please use dry packing materials that do not generate dust.

3. Name and Explanation of Each Part

3.1. External View

(HRM-150E)

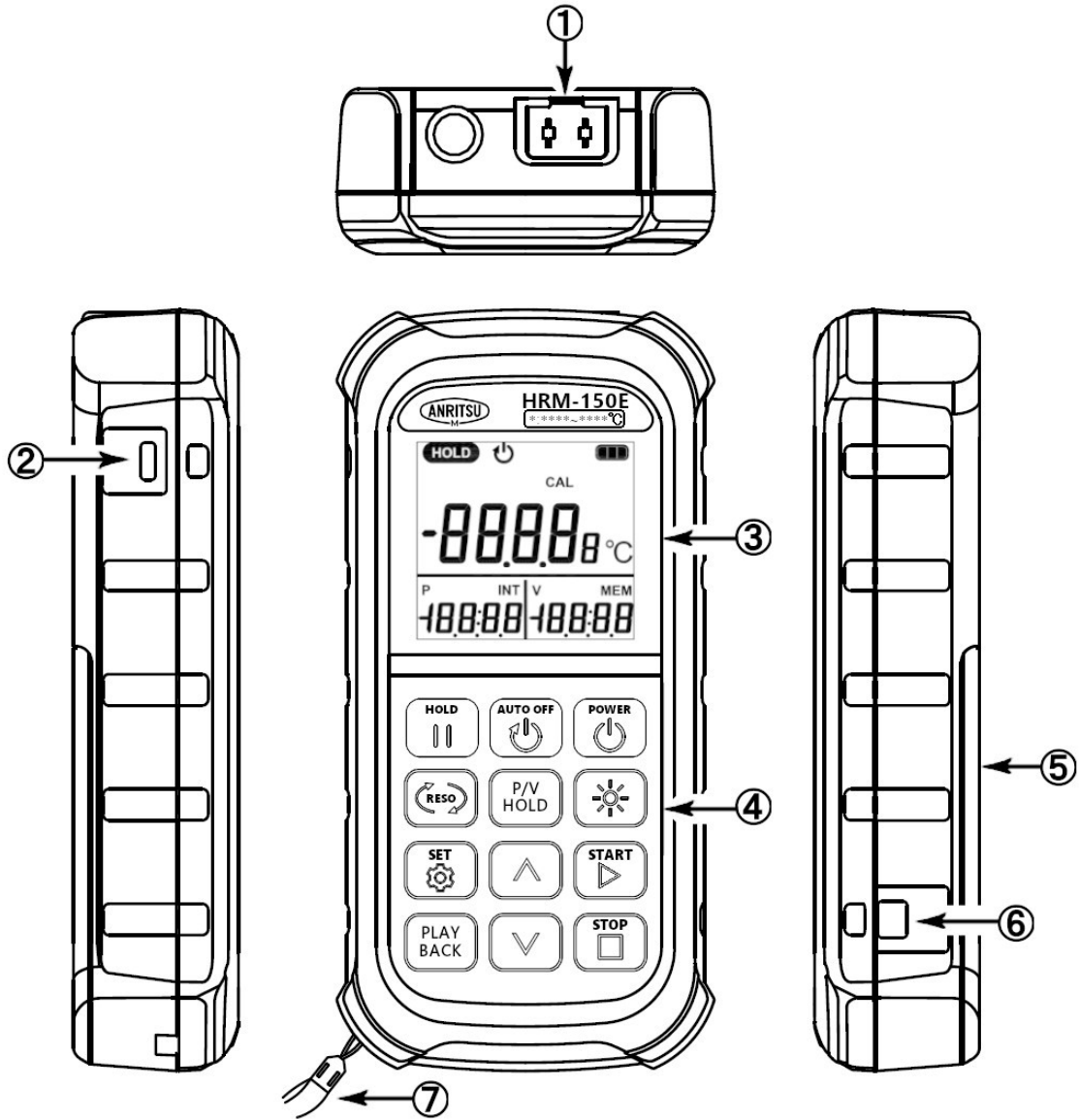

- ① Probe input connector
- ② USB connector
- ③ LCD display
- ④ Key switch panel
- ⑤ Battery housing
- ⑥ AC adaptor jack
- ⑦ Hand strap

3.2. LCD Display

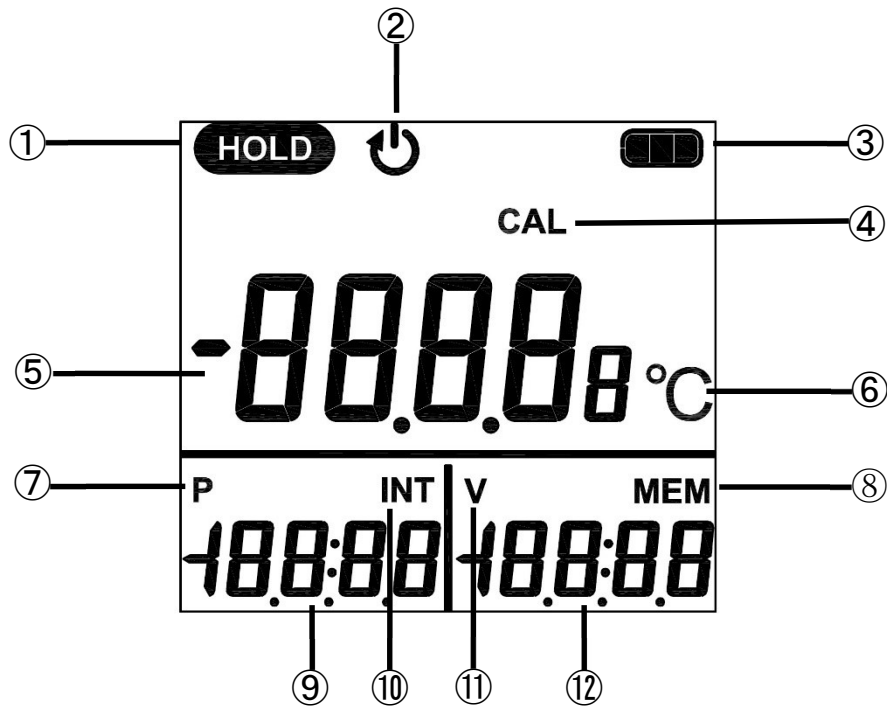

	Description
①	HOLD segment
②	A-OFF segment
③	Battery segment
④	CAL segment
⑤	Main display
⑥	°C segment
⑦	P segment
⑧	MEM segment
⑨	Sub display 1
⑩	INT segment
⑪	V segment
⑫	Sub display 2

4. Preparations Before Taking Measurements

4.1. How to Install the Batteries

Make sure to turn the power off when replacing batteries.

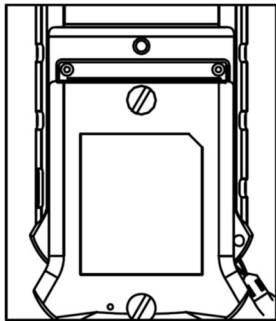

- (1) Loosen both screws and open the cover of the battery housing.

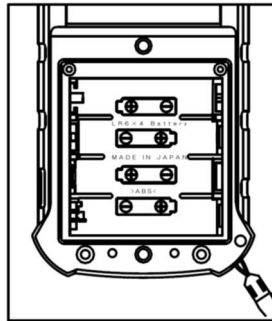

- (2) Pay attention to the orientation of the batteries.

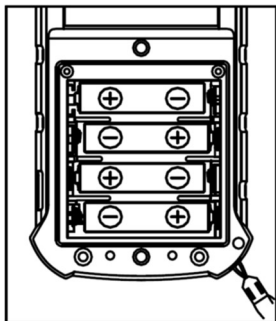

- (3) Install the batteries.

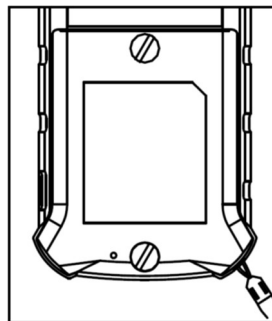

- (4) Reattach the battery housing cover, tighten both screws, and press the edge of the cover to secure it

4.2. How to Use the Hand Strap

Place the enclosed hand strap on your wrist to prevent the instrument from dropping.

Loop the thin cord of the strap through the hole and then pull the other end of the hand strap through that loop.

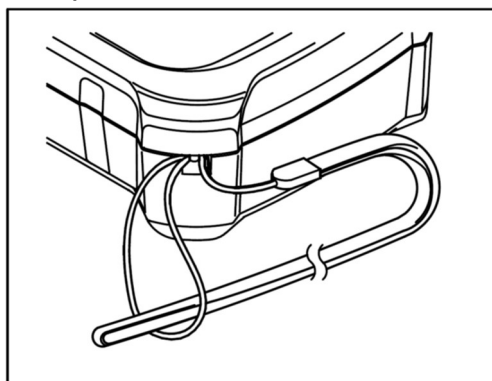

4.3. How to Use the AC Power Supply

- (1) Turn off the power of the instrument and then connect the connection plug of the AC adaptor to the main unit as follows:

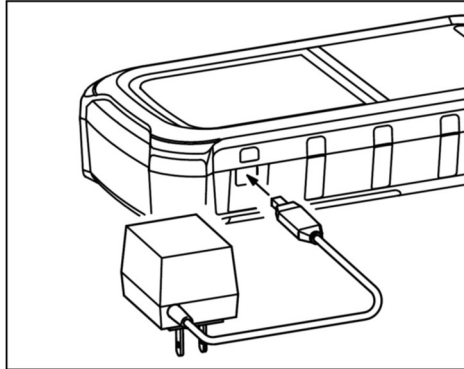

Note: The AC adaptor is available as an option. Please use one as specified by Anritsu Meter.

4.4. How to Set the Probe

Set the probe to the main unit as shown in the illustration below. It is designed so that if the probe orientation is incorrect, it cannot be fully inserted. If the probe is forcefully inserted, failure may result. Please check the probe's orientation before inserting it.

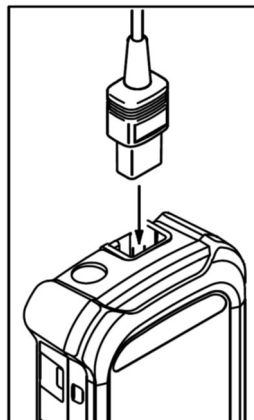

4.5. How to Use the Soft Case

To protect the instrument from dirt or scratches, etc., use the attached soft case. When using an AC adaptor, communication cable, open a hole at the relevant position on the soft case by using scissors or a similar object.

5. Operations and Functions

5.1. Power ON/OFF

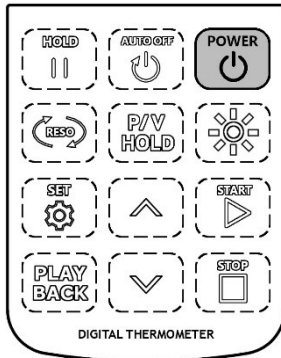

Pressing the **POWER** key will illuminate all the indicators for about three seconds and start measurements. Press the **POWER** key again to turn the instrument off.

All illuminated

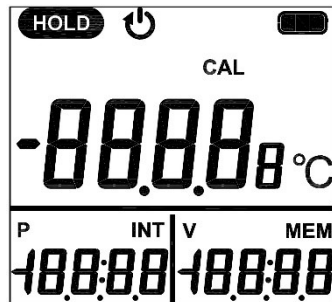

Automatic correction function ON/OFF



5.2. Automatic correction function

When the instrument is switched on with the probe with the IC tag (BSM Series/BUM Series/SFM Series) connected, CAL flashes and the instrument turns on the Automatic correction function. This mode enables a high accuracy measurement at a resolution of 0.01°C. Turning on the device with any other type of probe will turn off CAL and turn off the Automatic correction function feature.

Note: If CAL does not blink, turn on the power again.

Automatic correction function OFF

(CAL not illuminated)



Other probes

All illuminated

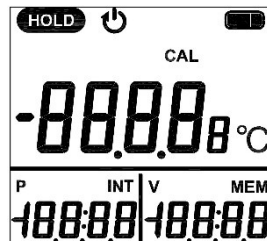

Dedicated probe

Automatic correction function ON

(CAL flashing)



5.3. HOLD Function

Press the **HOLD** key to maintain the indicated values during measurements. HOLD will illuminate on the screen while HOLD is on. To release the HOLD function, press the **HOLD** key again.

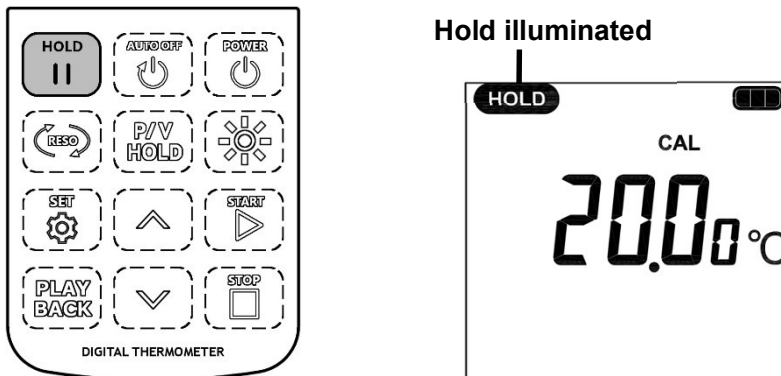

Notes:

- Use the functions below after releasing the HOLD function: Alarm function, P/V Hold function, and calibration function.
- The HOLD function cannot be used while burnout or overrange is displayed.

5.4. Automatic Power OFF Function

When the **AUTO OFF** key is pressed, “AUTO OFF” symbol will illuminate on the screen. If no key operation is performed for a certain period of time (about five minutes), the power will automatically be turned off, preventing the unit from remaining turned on. To release the AUTO OFF function, press the **AUTO OFF** key again.

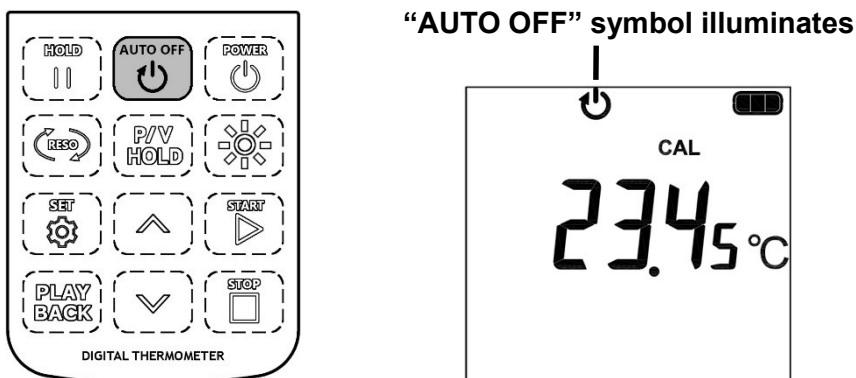

5.5. Resolution Change

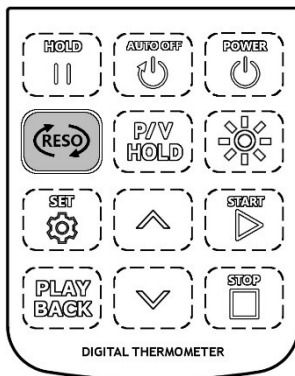

Press the **RESO** key to switch the resolution.

- 0.01°C resolution indication: The range between -104.99 and 199.99°C is displayed with the 0.01°C resolution. When the temperature goes out of this range, it will automatically be displayed with the 0.1°C resolution.
- 0.1°C resolution indication: The 0.1°C resolution indication is applied to all the range.

Note: Resolutions cannot be switched with the following functions: P/V Hold function, Alarm function, Burnout indication, and Overrange indication.

0.01°C resolution indication

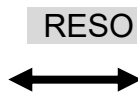

0.1°C resolution indication



5.6. P/V Hold Function

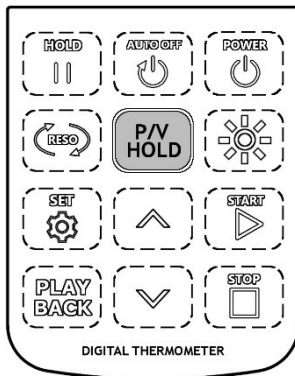

Press the **P/V-HOLD** key to enter the P/V Hold function. The lowest and highest values will be displayed in the sub-screens. Press the **P/V-HOLD** again to return to normal measurements.

Normal measurement



P/V mode

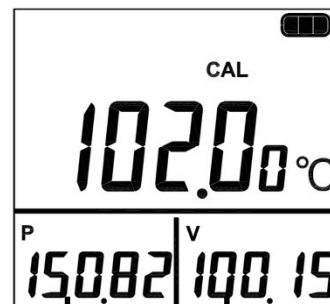

P/V-HOLD





Current
temperature

Max.
value

Min.
value

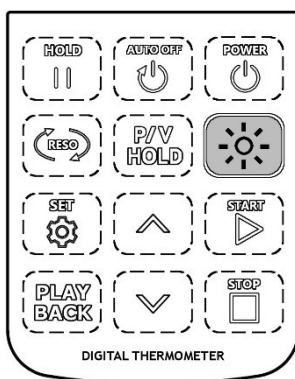
5.7. Turning the Backlight ON/OFF



Press the  key to turn on the backlight so that indications on the screen can be seen in dark places. Press the  key again to turn off the backlight.

Note: When the backlight is ON, more battery usage will be incurred. Don't forget to turn it off.

6. Time Setting

This product is equipped with a clock function. At the time of purchase or resetting the clock, please follow the steps below:

With the power of the instrument off, press the **AUTO OFF** and the **POWER** key at the same time to turn the instrument on.

The time setting screen will be displayed with the selected value flashing.

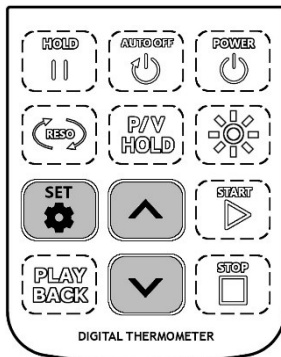
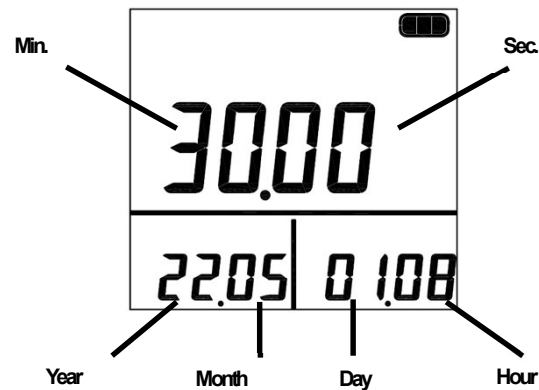
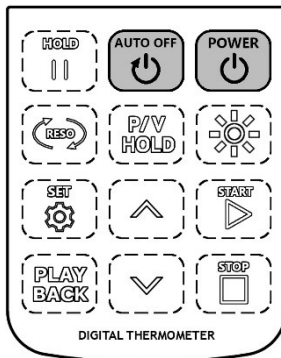

Use the **▲** and **▼** keys to increase/decrease the numerical value. To set the value, press the **SET** key.

Press the **SET** key with the minute selected, and the second will be set to "00" to complete time setting.

Notes: To avoid malfunction of the clock function, always use the instrument with batteries.

· Time setting can easily be done by using the dedicated software, AMS-350. For details, please refer to the user's manual of AMS-350.

7. Memory Function

7.1. Interval Setting

When the **SET** key is pressed, INT will be displayed and flashing in the left-bottom sub-screen, and the interval will illuminate.

Intervals will be switched in the order of 1 sec. → 5 sec. → 10 sec. → 30 sec. → 1 min. → 5 min. → 10 min. → 30 min. → 60 min. → manual by pressing the **▲** key in the reverse order with the **▼** key. Select the desired interval by pressing the **▲** and **▼** keys.

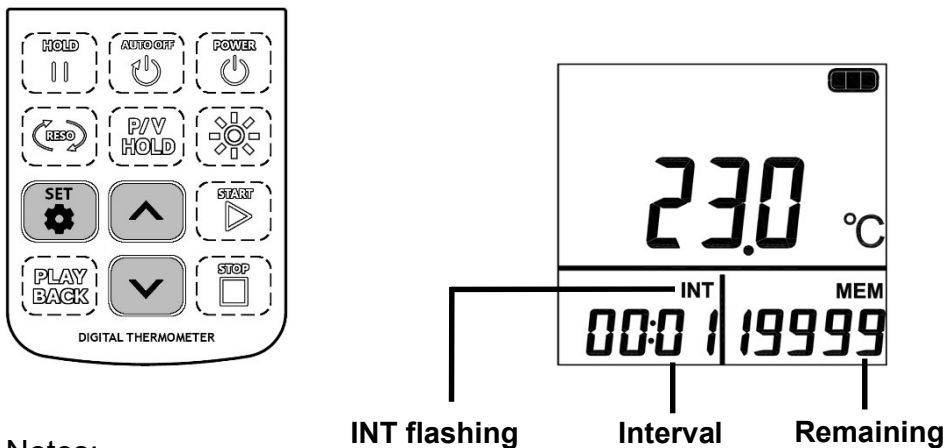

Notes:

- Max. number of memory data is 19,999.
 - During interval setting, the remaining number of memory available is indicated in the right-bottom sub-screen.
 - Press the **SET** key during the interval setting to return to normal measurements.
 - When the Automatic Power OFF function is enabled, this function will be disabled when memory measurements are started.
 - In the case of manual measurements, the interval indication will be “- - -”.
 - If interval measurements are conducted for a long time, always use the AC adaptor (optional).
- (Even when the AC adaptor is used, always mount batteries so that the clock IC is backed up.)
- Sampling period will be a user-selected time interval when time interval is specified at 10seconds or more.

7.2. Starting Memory Measurements

When the **START** key is pressed, INT will illuminate, and memory measurements will start at the displayed interval. To stop memory measurements, press the **STOP** key.

When the **STOP** key is pressed, measured data will be saved as a data block. Saved data blocks can be transferred to PCs, creating a data file for each block. (The maximum number of blocks is 200.)

Note: For details, please refer to the AMS-350 user's manual.

•Interval measurements

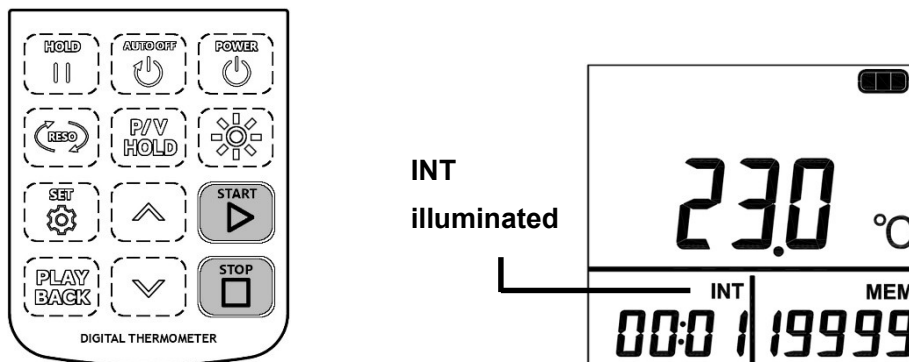

During memory measurements, pressing the **SET** key will switch the down-left sub-screen in the order of interval indication → clock indication → no. of block indication.

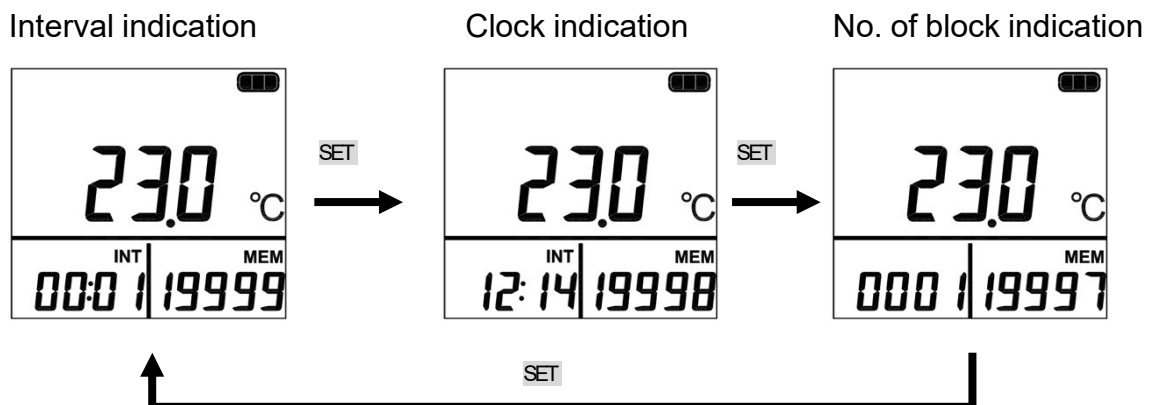

Memory measurements will be terminated when the remaining memory becomes zero (0) or the number of blocks reaches 200.

● Manual measurements

For manual measurements, every time the **START** key is pressed, the numerical value of the INT indication will increment, while that of the MEM indication will decrement. Measured temperature indications will be refreshed at an interval of about 200 ms, as is the case with normal measurements.

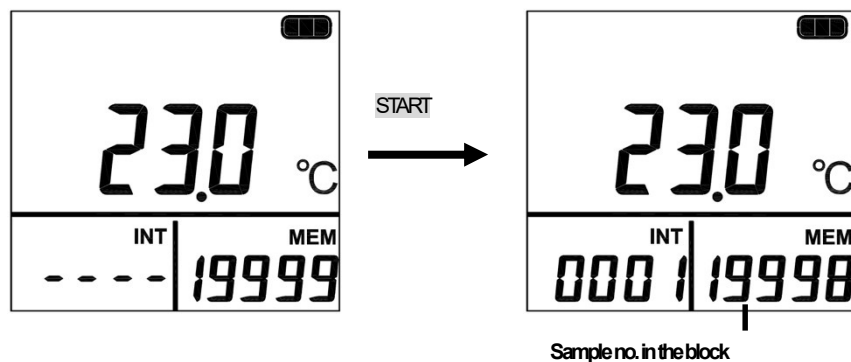

7.3. Memory Play back Function

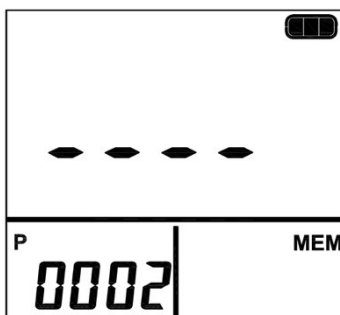

Block no. flashing

when the **PLAY BACK** key is pressed, indications of the P and the number of measured blocks (bottom-left of the screen) will start to flash. Select the block number to be displayed with the **▲** and **▼** keys and press the **SET** key to confirm the block no. Press the **SET** key again to return to the setting block number to be displayed.



Memory no. flashing

Note: If the number of blocks is just one (1), this value will not change when the **▲** or **▼** keys is pressed.

When the block no. to be displayed is set, MEM and memory no. indication (bottom-right of the screen) will flash, and the temperature of that memory no. will be displayed in the main screen. Select the memory no. to be displayed by using the **▲** and **▼** keys to display the temperature corresponding to the memory no. in the main screen.

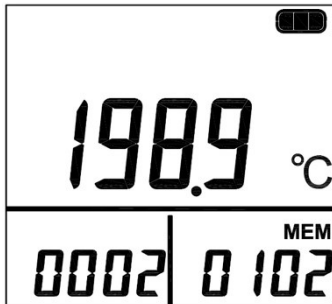

Note: Pressing and holding the **▲** and **▼** keys will increase the refresh rate of the display to x10 and x100.

Press the **PLAY BACK** key again to return to normal measurements (status before the **PLAY BACK** key was pressed.)

7.4. How to clear the Data

With the power of the instrument off, press the **SET** and the **POWER** keys at the same time to turn the instrument on.

The memory clear screen will be displayed. To delete data, press the **SET** key, and if you don't want to clear the data, press the **STOP** key.

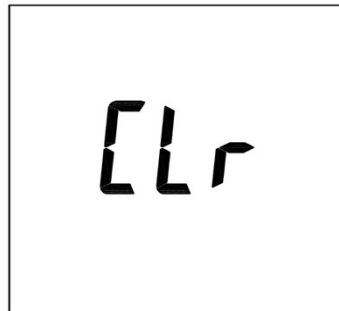
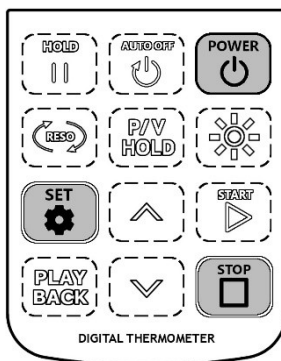

Note: Be extra cautious as once deleted, data cannot be recovered.

8. Dedicated Software AMS-350

The HRM-150 High accuracy handheld thermometer can communicate with PCs by using the AMS-350 dedicated software.

Please install the AMS-350 software as instructed in the included user's manual.

This software requires the following operating environment:

Supported OS : Microsoft Windows 10

Microsoft Windows 11

System types : 32 bit/64 bit

PCs that have sufficient specifications to run the above OS.

Notes

- We cannot guarantee that the software is operable on all PCs with the recommended environment.
- The software can be operated only by users with system administrator privileges (Administrator).
- Macintosh computers are not supported.
- Microsoft® Windows® 10 and Windows® 11 are registered trademarks or trademarks of Microsoft Corporation in the U.S.A., Japan, and other countries.

8.1. USB Connection

For the USB communication cable, use one with the USB A plug on the PC side and the USB micro-B plug on the instrument side. Connect the cable to the connector with the USB mark on the PC.

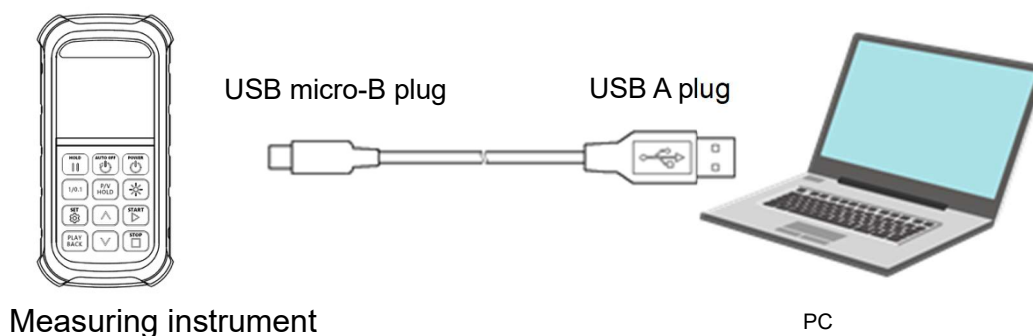

Note

- For details of communication connectors on the PC, please refer to the PC software instruction manual.
- When not communicating with a PC, always disconnect the instrument from the PC (by removing the communication cable.)
- If a different application is used while the instrument is connected, malfunctions and/or failures may occur.

8.2. How to Transfer Data in the Measuring Instrument

Data saved in the instrument is transferred to a PC to create files.

Confirm that the instrument is properly connected to the PC and then turn on the power of the instrument.

Launch the dedicated PC software, AMS-350.

From the [Setting (S)] menu, set the [Destination folder to save file] and [Serial port setting].

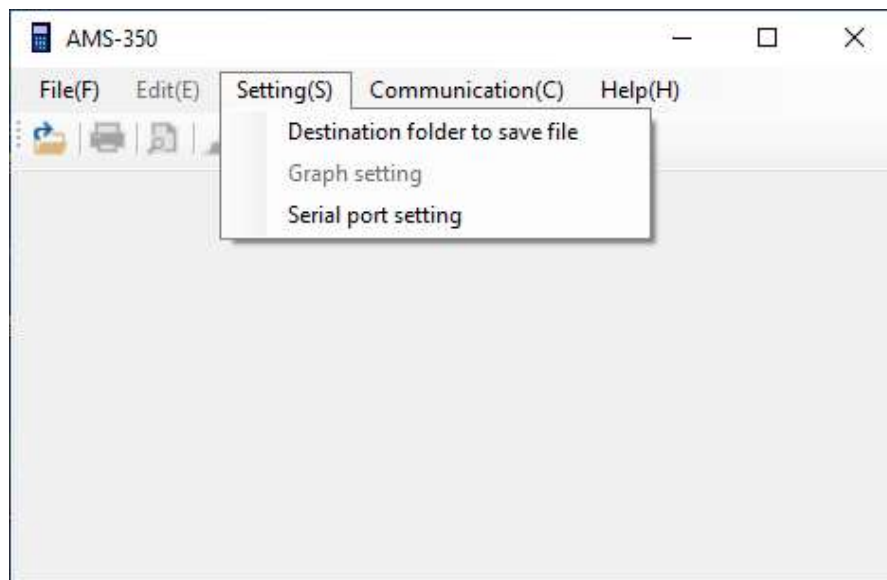

Set the destination to save data to be transferred.

Create a folder in an easy-to-find location on the PC and designate it as the destination.

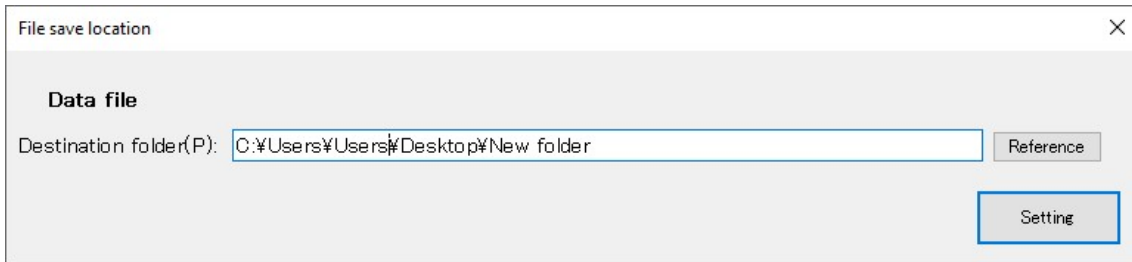

Every time AMS-350 starts, set the serial port.
To find the COM value, please refer to the AMS-350 user's manual.

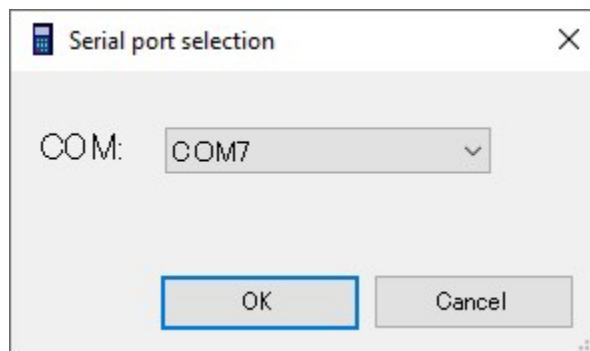

From the [Communication (C)] menu, select [Data input].
The “Do you want to start data input?” screen will be displayed.
Select [Yes] to start data input.

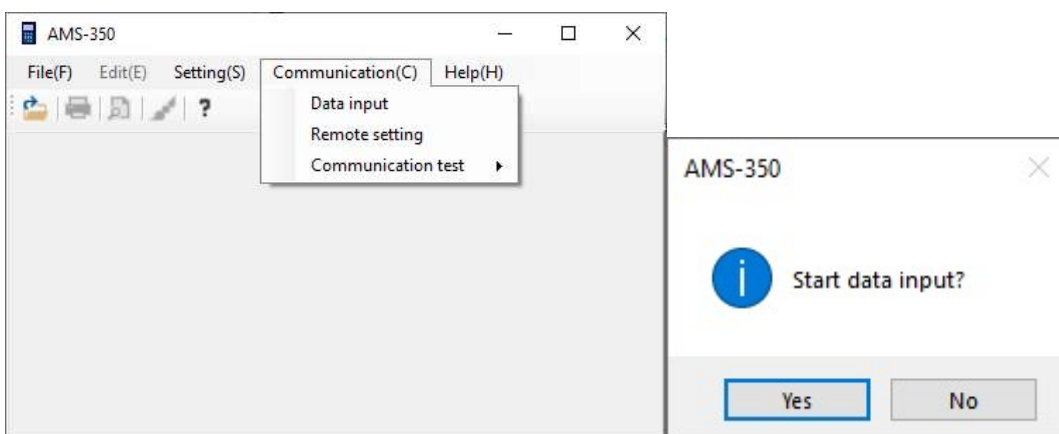

During communication, the transfer bar will be displayed to confirm the data transfer status. Press [Interrupt] to interrupt the communication without creating a file.

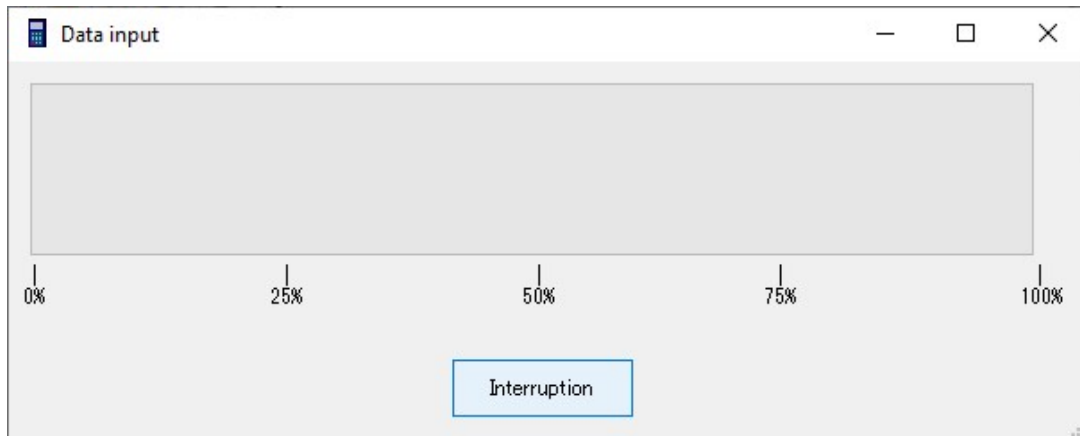

Do not operate any keys of the instrument during communication. Abnormal termination or a malfunction may result.

Note: After inputting data, the data on the instrument will be maintained. If any communication error occurs, please input the data again.

When all the data input is completed, a newly created data file will be displayed.

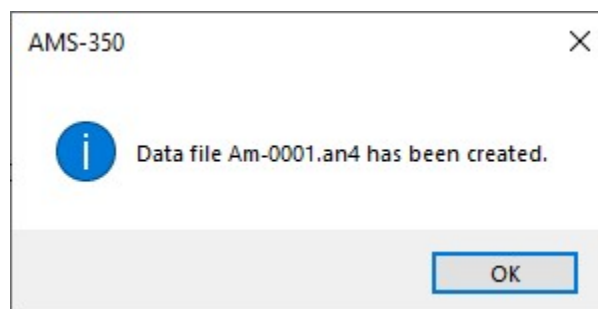

For further details, please refer to the user's manual of dedicated software, AMS-350.

The filename is [Am-****.an4].

The number from 0001 to 9999 will be sequentially given to [****] for each directory. Deleting any file will not affect other file numbers.

For example, if files up to #9999 are saved on the HD, the file #9999 will remain even if files #0001 to #9998 are all deleted.

In this case, as the file with the largest number (9999) is saved, no more data can be saved in this folder. If you want to save new data in this folder, change the filenames.

Ex: "Am-9999.an4" is renamed as "Am-0001.an4".

Function	
HOLD	Released
Automatic power OFF	Retained
P/V hold	Released
Resolution	Released
Backlight	Released
Time setting	Retained
Memory	Retained
Interval setting	Retained

Notes: Be sure to insert the battery to keep the time setting.

10. Checking the Remaining Battery

Remaining battery is displayed in the top right corner of the indication.

The remaining battery shows the continuous time of use in the rate shown in the table below.

As properties vary, depending on batteries, use this value only as a reference.

Remaining battery indication

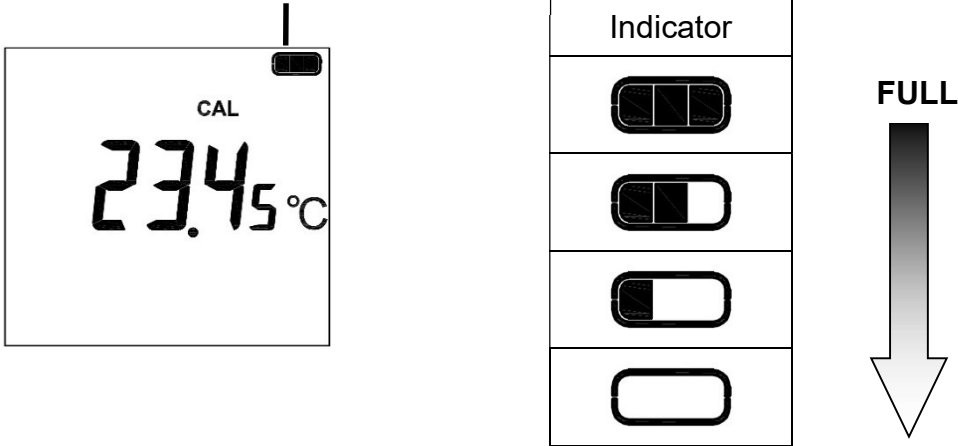

When the indication of the indicator becomes , replace the batteries with new ones.

11. Error Messages

11.1. Indication of a Broken Wire of the Probe



If the probe has a broken wire or is disconnected, the burnout (broken wire) indication is displayed.

If this indication is displayed, replace the probe with a new one or connect the probe.

11.2. Overrange Indication



When the temperature in measurement exceeds the measurable range, the overrange indication is displayed.

- If the wire of the probe is about to become broken, this overrange indication may be shown. If it is clear that the temperature in measurement is within the measurable range, check the probe.



- Even if the overrange indication is shown, it will not damage the instrument. However, the probe may be consumed, so relocate it to a place where the temperature is at a heat-resistant temperature or a lower temperature.

11.3. Battery Voltage Drop Indication



When batteries are depleted and the battery indication on the screen becomes , replace the batteries with new ones.

12. Maintenance

12.1. Storage

When storing this instrument, avoid the following places:

- In direct sunlight
- Subject to heavy vibrations
- High humidity (85%RH or more)
- High temperature atmosphere (50°C or higher)
- Filled with dust, waste, corrosive gas and/or salt
- High electromagnetic field

To store the instrument for a long time, it is recommended to remove the batteries and store the unit in the original packaging at the time of delivery.

12.2. When the Case of the Instrument Gets Dirty

When the case of the instrument gets dirty, please wipe it with a slightly damp cloth. Do not use alcohol, thinner, benzine, or other chemicals. Otherwise, the case or keyboard may become discolored or deformed.

13. Troubleshooting: Before Contacting Support

If you find any abnormalities or become unable to operate the instrument, first check for the following items. If you still cannot solve the issue, please contact your retailer or our company.

(1) The instrument does not operate when the power is turned on:

- Is the orientation of the batteries in the correct manner?

Reset the batteries.

- Have the batteries been depleted?

Install new batteries.

(2) The indicated values of temperature are unstable:

- Is the wire of the probe almost broken or is the probe deformed?

Do an appearance check of the probe.

- Is the probe connector inserted fully?

Re-insert the connector.

- Is the probe sufficiently making contact with the object of measurements?

Change how to set the probe.

- Is the measurement environment in a high electromagnetic field (such as a large motor)?

- Relocate the instrument or use the shield.

(3) If measurement errors are too large:

- Are the thermocouple types of the probe and this instrument the same?

Replace the probe.

- Is the head of the probe deformed?

Replace it with a new one.

(4) Keys are not responding:

- Is there any burn out (broken wire) indication shown?

Set the probe.

- Are any functions running?

Terminate various functions and retry to operate the keys.

(5) If memory measurements cannot start

- Is there a remaining memory block? Is the number of blocks exceeding 200?

After exporting the necessary measured data, clear the data.

Please refer to "7.4 How to Clear the Data".

14. HRM-150E Specifications

ASP specifications

Model (HRM-)		150	
Operation switches		Membrane keyboard (with clicking function)	
Input connector		ASP connector (thermocouple homogeneous metals)	
Input		Thermocouple Type E	
No. of input		One	
Signal source resistance		1 k Ω or less	
Measurement range		0.1°C resolution	-104.9 to 204.9°C
		0.01°C resolution	-104.99 to 199.99°C
Measurement accuracy	0.1°C resolution	-104.9 to 204.9°C	$\pm 0.1^\circ\text{C}$
	0.01°C resolution	-104.99 to 199.99°C	$\pm 0.10^\circ\text{C}$
Accuracy of reference junction compensation		$\pm 0.10^\circ\text{C}$ (at $25^\circ\text{C} \pm 10^\circ\text{C}$)	
Temperature coefficient (Only when exceeding $25^\circ\text{C} \pm 10^\circ\text{C}$)		$\pm 0.005 \times \Delta t^\circ\text{C}$ (Exceeded temperature Δt is multiplied by the coefficient and then added to the indication tolerance (measurement accuracy + accuracy of the reference junction compensation)) Ex. @ 50°C or 0°C environment: $\pm 0.075^\circ\text{C}$ added	
Operational conditions		0 to 50°C , within 0 to 80% RH (no condensation)	
Storage conditions		-20 to 50°C , within 0 to 85% RH (no condensation)	
Sampling frequency		*About 500 ms	
Linearizer method		Digital linearizer method (compliant with JIS C 1602-2015)	
Dimensions		82.1 × 166 × 36 mm (W × H × D) (Excluding connector extrusion)	

Weight		About 350 g (including batteries)
Memory function		See specifications (memory function)
Power supply		See Specifications (power supply)".
Accessories		See Specifications (accessories)".
RFID	Frequency	13.56MHz
	Type of Modulation	ASK
	Number of channels	1
	Maximum field strength	23.05dB μ V/m (Peak) @30m
	Compliant standard	Standard #: ARIB STD-T82 Type designation #: FC-20001 Standard #: CCAQ23LP0670T0 Standard #: ETSI EN 300 330

Notes:

- For probe resolution, please refer to individual probe specifications.
- Use the product when the temperature of the plug and the instrument reach room temperature.
- Sampling period will be a user-selected time interval when time interval is specified at 10seconds or more.

* About the tolerance

The indication tolerance on the main unit of the thermometer is calculated as "measurement accuracy + accuracy of reference junction compensation". However, this product is manufactured by customizing the reference junction compensation section for individual products. For this reason, the acceptance-rejection criterion at the time of shipment does not take the accuracy of the reference junction compensation into account and makes judgment for the measurement accuracy only. (This will narrow tolerance. The same applies to 0.01°C resolution. IC tags without correction are used for inspection.)

For actual use, please calculate the indication tolerance with the formula: measurement accuracy + accuracy of reference junction compensation.

If the value exceeds 25°C±10°C, the formula will be: measurement accuracy + accuracy of reference junction compensation + temperature coefficient.

Specifications (memory function)

Time interval	1second,5second,10second,30second,
---------------	------------------------------------

	1minute,5minutes,10minutes,30minutes,60miinutes and manual memory
Memory capacity	19999 data

* Sampling period will be a user-selected time interval when time interval is specified at 10seconds or more.

Specifications (power supply)

Model (HRM-)	150
Batteries	4 x Alkaline AA battery (LR6)
Battery life (continuous operation time)	About 450h
AC adaptor (optional) support	●

* When AC adaptor is mounted, the AC adaptor will be selected as the power supply.

* The HRM-150 has a built-in capacitor to maintain the clock settings. To recharge, please keep the batteries in the housing even when the product is being run by the AC adapter.

* Lithium batteries are not used.

* When using in NCC target countries (Taiwan), please select AC115V.

* AC adaptor (optional)

Type name: AD-100-500-HR-R (100 VAC input)

AD-115-500-HR-R (115 VAC input)

AD-220-500-HR-R (220 VAC input)

Specifications (accessories)

Common	Instruction manual
	Test report
	Warranty sheet
	Soft case
	Hand strap
	4 x Alkaline AA battery (LR6)
HRM-150	Communication cable (AM-USB2)
	*Dedicated software (AMS-300)

*The dedicated software switches between AMS-300/350 depending on the language settings of the computer being used. (The icon depends on the installer at the time of initial installation.

Jan. 2024 First edition AE-100303